



THE UNITED REPUBLIC OF TANZANIA

MINISTRY OF HEALTH AND SOCIAL WELFARE

Integrated Hospital Management System (iHMS) Implementation
Feasibility Study Report

Version 1.1, January 2015

Abbreviations and Acronyms

ERP	Enterprise Resource planning
HMIS	Health Management Information System
HQ	Headquarters
ICT	Information Communication and Technology
iHMS	Integrated Hospital Management System
LAN	Local Area Requirements
LMIS	Logistics Management Information System
M&E	Monitoring and Evaluation
MOHSW	Ministry of Health and Social Welfare
SDP	Service Delivery Point
SDP	System Development Plan
SO	Strategic Objective
SOMD	System Operation Maintenance Document
SOP	Standard Operating Procedure
SRS	System Requirements Specification
TZ	Tanzania

Table of Contents

Abbreviations and Acronyms	ii
Table of Contents.....	iii
1.0 Introduction	1
1.1 Background.....	1
1.2 An Overview of the iHMS.....	3
1.3 Terms of References (ToR) of the Consultancy.....	4
1.4 Objectives of the Consultancy.....	5
1.5 Deliverables of the Consultancy.....	6
1.6 Structure of the Report	7
2.1 Hospital Business Process Analysis and Areas for Improvement	13
2.2 Patient Care Management (Core) Processes	14
2.3 Pharmacy & Inventory Management Processes	31
2.4 Patient Billing Process	40
2.5 Account, Financial and Human Resource Management.....	45
3. Functional Requirements for iHMS.....	48
3.1 High level Requirement Summary	48
i. Patient Care Management	48
ii. Laboratory.....	48
iii. Billing	49
iv. Pharmacy and Inventory Management	49
v. Medical Record Management	49
vi. Human Resource Management	49
vii. Management Information System (MIS)	50
viii. Financial Management	50
ix. Integration and Information Exchange	50
x. Security and Confidentiality	50
4.1 Detailed Functional Requirements.....	51
4.1 Patient Care Management	51
4.2 Laboratory.....	54
4.3 Billing Business Process.....	57
4.4 Pharmacy and Inventory Business Process.....	61
4.5 Medical Record Management	70
4.6 Human Resource Management	71
Section 71	
Functional Description	71

Priority	71
4.7 Management Information System	71
4.8 Financial Management.....	72
5. iHMS System Architecture and Information Exchange.....	73
5.1 iHMS System Architecture	73
5.1.1 Architectural Choices	73
5.1.1.1 Best-of-Breed Model	73
5.1.1.2 Full-Integrated Model	75
5.2 iHMS Deployment Architecture	77
5.2.1.1 Facility-based Decentralized system model	77
5.2.1.2 Cloud-based Centralized system model.....	78
5.3 iHMS and the National HIS Architecture	79
Standards.....	82
5.3.1 Contents Standards	83
5.3.2 Data Format Standards.....	83
5.3.2.1 Health Level 7(HL7)	84
5.3.2 Coding Standards.....	84
5.3.2.1 ICD and SNOMED CT	84
6. Assessment of Existing Information Systems in Health Facilities	85
6.1 Characteristics of Surveyed Health Facilities and Assessment Tool.....	85
6.2 Findings of Existing Information Systems	85
6.3 Conclusion and Recommendations.....	87
7.0 Acquisition and Implementation of an iHMS.....	89
7.1 Acquiring an iHMS	89
7.2 Recommendations during acquisition	89
7.3 Make and Build from scratch or customization of an existing software ..	90
7.4 Purchasing an existing software (Commercial-off-the-shelf software).....	90
7.5 Implementing the iHMS.....	92
7.5.1 Introduction.....	92
7.5.3 Testing phase.....	96
7.4 Computing Infrastructure Requirements	97
7.4.1 Data Centre /Server room	100
7.4.2 Networks and Internet Connectivity.....	102
7.4.3 Workstations.....	103
7.4.4 Computer training room.....	104

7.4.5	Physical and logical security of ICT infrastructure	104
7.5	Human Resource Requirements	105
7.6	Training Requirements.....	109
7.7	Managing and Supporting HMS Operations	116
8	Governance Model and Policy.....	119
8.1	iHMS Project Steering Committee	121
8.2	Change management and adaption.....	129
8.7	Appendix A: Implementation Plan.....	132
8.8	Appendix B: Visited Health Facilities.....	132
8.9	Appendix C: Implementation Budget.....	132
8.10	Appendix D: Evaluation of existing HMS Functionalitie.....	132
8.11	Appendix E: Example Schematic Network Designõ õ õ õ õ	132

LIST OF TABLES

Table 2.1 : Patient registration process details	16
Table 2.2: Admission Process/detail	21
Table 2.4: Appointment business process details	26
Table 2.5 : Pharmacy & Inventory Management business process	32
Table 2.6 Medical supplies distribution process details.....	36
Table 2.7: Dispensing process detail	39
Table 2.8: Patient Registration and admission process	42
Table 2.9: Patient outstanding account process details	46
Table 6.2: Characteristics of Existing Systems	87
Table 7.1: Computing Infrastructure requirements..... Error! Bookmark not defined.	
Table 7.2: Recommended estimates for key ICT cadres for each hospital level:	105
Table 8.1: iHMS Steering Committee: Members Zonal Hospitals	128
Table 8.3: iHMIS Steering Committee Members: District.....	129
Table 8.2: iHMIS Steering Committee Members: Regional.....	128
Table 8.4 : iHMIS risks and mitigation strategies	130
Table 8.5: iHMIS key success factors	131

LIST OF FIGURES

Figure 2.1: Hospital Business Process Framework.....	13
Figure 2.2: Patient Registration Process.....	16
Figure 2.3 : Admission process.....	20
Figure 2.4: Pharmacy & Inventory Management business process	31
Figure 2.5: Medical supplies distribution process.....	35
Figure 2.6: Dispensing process detail	39
Figure 2.7: Patient Registration and admission process	42
Figure 5.1: Full Integrated iHMS Architecture	76
Figure 5.2: Cloud-based Solution for iHMS.....	79
Table 6.1: Hospital Supported Functions	86
Figure 5.3: Proposed National HIS Architecture	81
Figure 7.1: Alternatives of acquiring a software (Peter Lo, 2007)	89
Figure 8.1: The proposed iHMS governance structure at different levels....	120
Figure 8. 2: The proposed composition of iHMS implementation teams at different levels.....	121
Figure 2.1: Hospital Business Process Framework.....	13
Figure 2.2: Patient Registration Process.....	16
Figure 2.3 : Admission process.....	20
Figure 2.4: Pharmacy & Inventory Management business process	31
Figure 2.5: Medical supplies distribution process.....	35
Figure 2.6: Dispensing process detail	39
Figure 2.7: Patient Registration and admission process	42
Figure 5.1: Full Integrated iHMS Architecture	76
Figure 5.2: Cloud-based Solution for iHMS.....	79
Figure 5.3: Proposed National HIS Architecture	81
Figure 7.1: Alternatives of acquiring a software (Peter Lo, 2007)	89
Figure 8.1: The proposed iHMS governance structure at different levels....	120
Figure 8. 2: The proposed composition of iHMS implementation teams at different levels.....	121

1.0 Introduction

This report focuses on the feasibility of implementing an Integrated Hospital Management System (iHMS) in Tanzanian hospital settings. Chapter 1 covers the foundation of this report. In Section 1.1, a background of the assignment is presented which includes the overview of the health delivery challenges and rationale for addressing the situation. Section 1.2 provides clarification on the use of the term "Integrated Hospital Management System" (iHMS) over other similar terms in the health domain. Section 1.3 to 1.5 covers Terms of References (ToR) as obtained from the client, Objectives of the assignment as understood by the consultant, and deliverables of the assignment respectively. This chapter concludes with a synopsis of the report.

1.1 Background

The mission of the Ministry of Health and Social Welfare (MoHSW) is to facilitate the provision of quality health and social welfare to all people to enable them to improve their well-being (HSSP III, 2009). Despite the noticeable improvement towards this mission, the sector still faces several challenges which hinder provision of accessible, efficient and quality health care services to all people. These challenges include population growth relative to economic growth, escalating health related costs (health staff training, medicine and medical equipment), dependence on scarce government subvention, shortage of qualified health professional, and inefficiencies in the use of available resources to adequately provide proper health services. The latter is a primary concern which influences other challenges.

Among the reforms in the health care sector implemented by the ministry is the introduction of cost-sharing scheme in attempt to raise additional revenues from health facilities (HSSP III, 2009). To achieve maximum benefit, the ministry need to address at least two concerns emanating from this reform. The first concern is to ensure all genuine revenues are collected, recorded and reach relevant authority. To address this concern, the ministry should put in place implementable mechanisms for ensuring effective

revenues collection. It is worth to note that the reform came to replace the old system where majority of health services were free for all and the new cost sharing scheme came with some fee waiver components for some vulnerable groups. Thus, effective and efficient revenue collection under cost-sharing scheme requires review and re-engineering of hospital business processes. The second concern is controlling expenditure and service delivery at the health facilities. All of these require re-engineering of hospital business processes in order to increase net income and reduce the impact of shortage of funds in delivering accessible, efficient and quality health care services.

Parallel to re-engineering hospital business processes, automation of well-defined hospital business process is vital for improving management of scarce resources, reducing workload and increasing productivity. To achieve best results of controlling health resources, the automated system must be able to capture process and disseminate relevant information across all functional units possibly from health facilities to the ministry. This necessitates the need to have an integrated Hospital Management System (iHMS) that implements the re-engineered hospital business processes in order to facilitate effective and efficient health resource (include financial and human capital) management. Also, this is in line with the strategic objective 4 (SO4) of the eHealth Strategy of the ministry which focuses on the use of information technology on financial and resource management (eHealth, 2009).

Furthermore, automation of clinical and administrative functions of health facilities and related coordination units is important for improving efficiency in hospital operations. Also, it enhances provision of quality information for decision making at various levels in the health sector management structures. Thus, improving efficiency and quality of health care delivery.

On this note, efforts to computerise various clinical and administrative functions have been noticeable worldwide, and in some health facilities in Tanzania. Though the degree of success on automation has been varying due to contextual factors, there is significant improvement in management of health resources. To cite few cases, deployment of hospital management

system (Jeeva) at the Mihimbili National Hospital (MNH) has improved management of health resources. Also, deployment of Care 2X integrated with Web-ERP as its hospital management system at Mbeya referral hospital, and deployment of AfyaPro at Bombo referral hospital are typical examples in this trend.

In order for the ministry to tap the potential of information technology by successfully implementing an integrated system to automate hospital processes, a national level framework and implementation plan is inevitable. These will guide gathering and prioritise functional and non-functional needs of the system by involving all potential stakeholders such as health care practitioners, public, and relevant ministries. In response to this, the Ministry of Health and Social Welfare through the Basic Health Service Project (BHSP) has decided to conduct the need assessment and develop the roadmap for the implementation. Specifically this will include requirement specification for iHMS, guidelines and standards, and road map for implementation.

The Basic Health Services Project is designed under Sector wide approach WAP, to assist the Government in improving the equity of geographic access and use of basic health services across districts and enhancing the quality of health services being delivered. The project intends to improve public financial management and health resources at local levels including health sector institutions, Local Government Authorities and regional oversight structures.

1.2 An Overview of the iHMS

The health care domain is diverse and contains various application areas for technology deployment. This results into lack of naming standard for what constitute hospital management system. For clarity of this report, we put forward the following definition:

- a) An Integrated Hospital Management System (iHMS) is referred as single system or collection of integrated systems that automate both clinical and administrative processes in the hospital settings. In the context of this report, iHMS can be implemented in any chosen architecture (cloud architecture, federated system, or other).

- b) Hospital Management System is referred to any automated system in the hospital setting which cover either one or several of clinical functions or administrative function. We opt to retain this definition in order to maintain consistency with reported existing systems in use by health facilities and at the ministry.

1.3 Terms of References (ToR) of the Consultancy

This consultancy involves devising and drafting requirement specification, high level system architecture, and guidelines for implementing the Integrated Hospital Management System (iHMS). Also, the scope includes development of the terms of reference for the consultancy to implement the iHMS. The list of activities as per given ToR are:

Planning

- a) Prepare a detailed project plan defining activities, milestones, deliverables, resources, and time estimates according to the requirements
- b) Mapping of existing Information Systems (IS) in use in hospitals in Tanzania
- c) Identification of suitable Information Systems (IS) in use in a similar setting in other countries that could readily and cost effectively be implemented, maintained and supported in Tanzania.

Business process analysis and redesign

- d) Perform analysis of business processes in district and referral hospitals to identify exact scope of proposed iHMS. Identify the process re-engineering opportunities that may affect the key requirements for the iHMS.
- e) Provide business process redesign (re-engineering) proposals as appropriate.

Requirement specification

- f) Define and prioritise the key requirements (business requirements, functional and non-functional requirements) for iHMS for; a) district and b) referral hospitals.
- g) Identify infrastructure (hardware, networks, etc.) requirements for iHMS deployment
- h) Prepare overall requirement specification (software requirement specification) and infrastructure requirement specification

System selection Planning

- i) Develop an evaluation tool for standardized assessment of different systems based on the key features of the software requirement specification
- j) Conceptualization of roll-out and on-going maintenance, development and support of iHMS to all government district and referral hospitals.

Development of a comprehensive implementation plan and budget.

- k) Prepare terms of reference for the consultancy service and support team to implement a recommended iHMS.
- l) Prepare terms of reference for the consultancy service to implement the required infrastructure to support the deployment of iHMS.

1.4 Objectives of the Consultancy

The consultant understood that the assignment involves conducting feasibility study is to undertake needs assessment, provide MoHSW with features of the iHMS and high-level architectural design, implementation plan.

Specific objectives are as follows:

- a) To analyze clinical and administrative business processes (i.e. payroll, accounts, billing, procurements, etc) and identify possible opportunities for improvements

- b) To develop iHMS features with costing to meet business functional and non-functional requirements. This includes development of hardware, software, training, support requirements.
- c) To perform assessment of existing system for Tanzanian Health Facilities.
- d) To define a set of guidelines and standards for Implementing iHMS in Tanzania
- e) To provide the MoHSW with practical guidance and a road map on the implementation of iHMS at district and regional, zonal and national referral hospitals in the country.
- f) To provide the MoHSW with terms of reference (TOR) for consultancies and / or national team required in supporting implementation of the iHMS and related ICT infrastructure.

1.5 Deliverables of the Consultancy

At the end of this feasibility study the following deliverables shall be available to the MOHSW and relevant agencies:

- a) Analysis of the current business processes and suggested business process maps, documented high level architecture of business processes (business reengineering) models/maps for both clinical and administrative functions.
- b) iHMS Functional and Non-Functional Requirements
- c) Detailed iHMS infrastructure requirement specification
- d) iHMS high level System Architecture.
- e) Guidelines and budget for implementing the iHMS at different levels including national, zonal and regional referral hospitals
- f) Final report and recommendations, including and implementation plan and budget.
- g) Terms of reference for consultancies and/ or national team required to support development and implementation of the iHMS and related ICT infrastructure.

1.6 Structure of the Report

Chapter two presents the methodology used in the feasibility study.

Chapter three presents analysis of hospital business process

Chapter four presents functional requirements of the proposed system

Chapter five presents the proposed high level architecture of the proposed system

Chapter six presents the assessment of existing information systems in health facilities.

Chapter seven presents implementation guidelines

Chapter eight presents governance model and policy issues

Chapter nine presents appendices

2.0 Methodology

Overall we have adopted a collaborative requirements development methodology (CRDM)¹. This approach was chosen because it has proved to be successful in similar project in the health sector. In the Tanzanian context, the first broad application of this methodology was in the domain of logistic management and supply chain. Central to the application of CRDM is the application of business process analysis and modeling in a richly collaborative manner with users, subject matter experts and other stakeholders. Every organization performs a chain of events, activities and decisions that ultimately add value to the organization and its customers. These chains of events, activities and decisions are called business processes.

The activities of this feasibility study as guided by the CRDM were structured around four phases: planning and research, field validation, analysis and documentation, and implementation planning and reporting. Below we describe the activities performed in each phase and point out the methods employed to perform the activity.

Phase 1: Planning and Research

The initial phase of this study was planning and research. Activities included in this phase were desk review, hospital business process identification, investigation of systems requirements for the iHMS and tool development for conducting the feasibility study.

Desk review. In order to provide appropriate guidance of the feasibility study for the development of the road map for iHMS, it was important to gain a better understanding of how hospitals and the health sector in Tanzania operates. Therefore as the first activity we studied different strategies, plans and policies for the Ministry of Health and Social Welfare (MOHSW) and the health sector in general. The studied document includes the Health Sector Strategic Plan III (HSSP III), National eHealth Strategy (2013-2018),

¹ Common Requirements for Logistic Management Information System

Comprehensive Hospital Operational Plan (CHOP), and Comprehensive Council Health Plan (CCHP).

Business process identification. As the second activity, hospital business processes relevant to the business problem being addressed were identified. This included delimitation of the scope of these processes as well as identification of the relationship between them. The outcome of this activity was a hospital business process framework that provided a holistic view of the processes in a hospital setting and how they are related. This was done through studying the CHOP; visiting and interviewing individuals from one selected hospital in Dar es Salaam, as well as our experience of hospital operations.

Preliminary requirements investigation. Also during initial phase, we identified system requirements for the iHMS. Hospital operations constitutes complex and many business processes. Identifying requirements directly from users could have been difficult. To avoid this challenge we investigated and documented preliminary user and system requirements of the information system for each identified business process. The requirements were identified from the existing systems with good track record, literature, our experience on hospital management system and industrial best practices.

Study Tools Development. As part of the planning and preparation for the field visit, we developed several tools for analysis of business processes requirement testing, and computing infrastructure identification.

Phase2: Field Validation

In the first phase our team of experts visited several hospitals (zonal and regional referral hospitals, and district hospitals) identified by the Ministry. During the field visit, our team worked closely with key stakeholders in selected hospitals including Regional Medical Officers (RMOs), District Medical Officers (DMOs), hospital medical in charge officers and executive directors, and head and operational staff from each functional department. The team performed various activities including analysis of business processes, testing of the system requirements, elicitation of computing

infrastructure requirements, training need assessment, and human resource requirements.

Analysis of business processes. The main goal here was to understand hospital business process in detail and identify and document problems associated to the as-is processes. In this activity we interviewed and discussed with head and operational staff from each functional department of the hospital. Ranging from the medical officer in-charge, clinical departments, pharmacy, billing and accounts. Our focus was to identify any bottleneck that causes mismanagement of health resources and inefficiencies in the hospital operations. The output of this activity is collection of challenges and possible solution for each business process.

Testing of the requirements. Testing of the requirements aimed at determined whether users agree with the proposed user and system requirements and identify the gap for inclusion or elimination. The result from this activity included refined requirements for the hospital management system. Users had the opportunity to identify missing requirements, which are included in the final requirement specification presented in Section **Error! Reference source not found.** of this document. The testing and refinement were achieved through three main methods (1) using the questionnaire-administered interviews to patients, doctors, nurses, business developers and administrators, social workers, executives, insurers and other stakeholders (2) observations of hospital operations and (3) document review.

As part of this activity, we identified requirements of the computing infrastructure necessary to support implementation of the iHMS in respective hospitals. This was also achieved through a questionnaire-administered interview and observation during the field visit. The computing infrastructure includes network infrastructure, computers, power and cooling system, IT personnel and other infrastructures such as building for hosting data center and telemedicine center. In addition, we performed a training need assessment to determine necessary training requirement that must be provided to users to enable them successful use the proposed system.

Phase 3: Analysis, Redesign and Documentation

Analysis. In this phase data collected from respective hospitals were analyzed to identify challenges and possible areas for improvement for some of the processes. Like wise the analysis of the requirements testing and refinement from various users in different hospitals provided the opportunity to specify a set of requirement for the iHMS. This was done through expert team discussions, brainstorming and whenever necessary we consulted the MOHSH team as well as health practitioners who have long experience in the health sector industry. The results of this analysis include the business process description, which include challenges and recommendation for improvements. In addition, the results include the refined and documented set of requirements for the iHMS. Furthermore, the results included the computing infrastructure requirements that included among other things IT personnel and training need for successful implementation of the iHMS.

Standards development. Standards development is a very important activity that required a considerable amount of time to allow a broad stakeholder involvement. After consultation with the Ministry IT team, due to time limitation it was agreed that we identify minimum standards that are fundamental for iHMS implementation. For this purpose we reviewed standards adapted by neighboring countries as well as international standards from which we have identified candidate standards that must be supported by iHMS.

System Architecture Design. Following a detailed analysis of the established requirements and our experience in systems and enterprise architecture we have designed high-level system architecture for the iHMS. We have also pointed out possible iHMS deployment architecture. The purpose of the architecture is not to guide the development of the iHMS but to serve as a communication tool to help decision makers and the stakeholder on deciding the system and deployment architecture that suite the Tanzanian needs and problems. Also through working closely with MOHSH, we have specified systems as components of the possible national health information system architecture. While there is no developed and agreed national HIS

architecture, we have adapted the OpenHIE model after consultation and discussion with MOHSW IT team. The purpose was to identify and indicate possible information exchanges required between iHMS and other components of the overall National HIS Architecture. This is important, as it will influence the planning and selection of the iHMS solution.

Assessment of existing HMS. Assessment of the existing systems implemented in Tanzanian hospital setting was among the major activities performed in the second phase of the study. The primary purpose of the assessment was to identify possible solution(s), which could be used by the Ministry for the implementation and scale up to other facilities. The established requirements were then used to establish a tool (see Appendix C) for evaluating systems. Therefore the assessment was based upon a goodness of fit to the requirements. It did not cover other aspects that are critical for making a selection of the systems such as capability of the vendor, total cost of ownership, maintenance and support, which could only be accessed from the vendors.

Different methods were used for the assessment. The main method was field visit where the system was evaluated to see the extent it meet the established requirements. Apart from field visit we were able to use IT personnel of respective hospitals to perform extended assessment of the system based on the tool. For hospital, which we were unable to visit, phone calls were used to reach the IT personnel who then performed the evaluation using the tool. We also performed desk review to identify possible candidate systems within and outside the country with good track record. We were able to identify some of the system in neighboring countries such Namibia.

Phase 4: Implementation plan and report development

In the final phase we developed a national implementation plan and budget for the iHMS. Included in this phase is the development of the feasibility study report (this document). Twiga Hosting closely worked with MOHSW to prepare an implementation plan that includes budget and timeframe for implementing both computing infrastructure and iHMS in selected hospitals. As part of the implementation plan, we have developed terms of references

for implementing computing infrastructure necessary for iHMS implementation.

2.1 Hospital Business Process Analysis and Areas for Improvement

This section presents an analysis of hospital business processes we have performed to identify areas for improvement. **Error! Reference source not found.** presents an overview of the hospital business processes framework, which includes several business processes classified as core processes, support processes and back office processes. The purpose of the framework is to provide sufficient details to describe how hospitals actually operate as comprehensive as possible but at a high level, in a bid to broadly communicate what actually happens in the hospital settings.

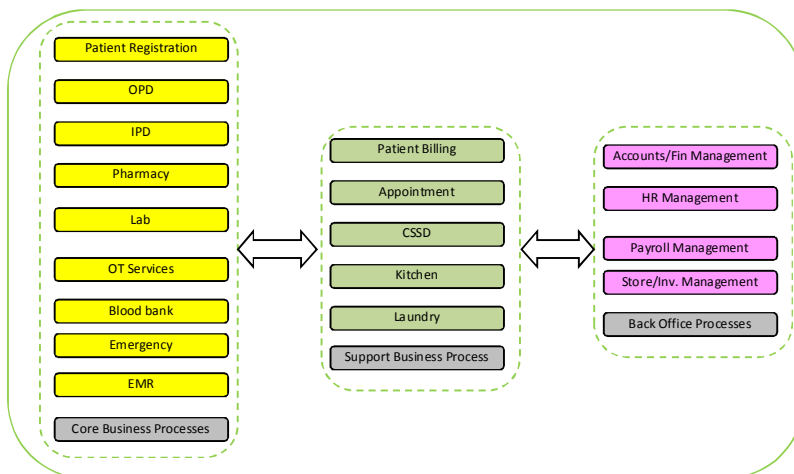

Figure 2.1: Hospital Business Process Framework

Following the analysis of all business processes based on the framework, we have

- Identified the major functional areas a hospital management system must possess to improve the management and operations
- Identified challenges and recommended possible process improvements
- Developed a flow of activities for recommended process improvement

In the following sub sections we describe the identified business processes, challenges, process improvement recommendation and to be process map.

Each business process is described by three key elements; descriptive text, flow chart diagram, and a table to elaborate flow chart. Processes in the flow chart are numbered in the same way as its associated descriptions in the tables.

2.2 Patient Care Management (Core) Processes

Patient care management processes relates to the core business processes of the hospital as proposed in the framework in **Error! Reference source not found.** While there are several processes within the core processes of the hospital, only processes, which indicated the need for improvement, are discussed. These include the registration, admission, laboratory, and scheduling appointment.

A. Patient Registration Process

Patient registration process involves activities such as capturing of accurate demographic details for new patients, updating of the information for follow up patients, creating correct clinical patient record depending on the nature of health problem and deciding on the required mechanism of payment of bills. Refer figure 2.2. and table 2.1.

Challenges

- ***Unnecessary patient queues:*** In the course of the feasibility study in different health facilities we observed that the registration process takes prolonged time due to a number of counters which a patient has to go through before completing the process. For example at Bugando and in other facilities with patients which are under credit companies such as NHIF, we observed that patient has to pass through three (3) queues before being attended by a doctor. The queues for patients under credit companies include patient registration and identification, insurance membership verification, and medical consultation queue.
- ***Un-authorized patients:*** It was also observed that there is a discrepancy between patients seen by a doctor and those passing through proper registration channels. While registration clerks and doctors strive to do their work well, the clerks and even the doctors do not have a means to verify if all patients being attended went through the formal registration process. This creates a loophole where some patients may be slotted in to see the doctor without being registered and therefore leading to discrepancies in revenue collection.

Recommended process improvement

- Integrate patient registration and verification activities to be performed at the same center to avoid multiple patient queues.
- Use of iHMS to eliminate corridor/unregistered patients from being attended by clinicians by providing integration and information sharing between registration and consultation.

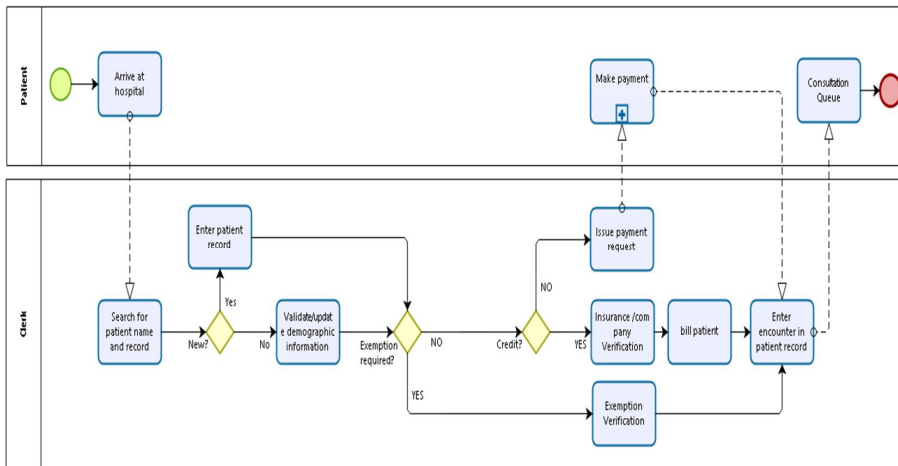

Figure 2.2: Patient Registration Process

Table 2.1 : Patient registration process details

Objective: Initiate record of patient visit and validate patient identification and billing coverage		
1. Arrive to hospital Patients meet the clerk and provide appointment card or referral letter or self-referral.	7. Exemption verification Verify to determine whether the patient is exempted or not.	12. Make payment The cash patient will settle the payment to the revenue collector
2. Search patient's records.name and record Retrieve patient record through identifying information collected. A search will need to be done first on all patients in order	8. Credit? Check whether, the patient is a credit or a cash patient.	13. Enter encounter to patient record Document current encounter to create record of the visit.

to avoid duplicates.		
<p>3. New patient? Identify whether the patient has an existing record or is a first-time user.</p> <p>4. Enter patient record Create a patient record in the system for new Patients. Record demographic information with proof of identification.</p>	<p>9. Credit verification For credit patient, the clerk will verify and register the patient, and provide patient with a form to be filled at each step of service provision. Insured claim form will be signed by both parties, the patient and doctor, the insurance card will be kept by the clerk and provided to the patient at the end of services.</p>	<p>14. Consultation queue Nurse will assign order according to the prioritization process based on time of arrival. Wait for clinician to conduct consultation.</p>
<p>5. Validate/update demographic information Display patient information that can be edited for updates so the clerk can verify identification of patient.</p>	<p>10. Issue payment request For cash patient, the clerk will provide cost of all services and provide payment sheet to patient for settlement.</p>	
<p>6. Exemption required Identify whether the patient is entitled for exemption.</p>	<p>11. Bill patient For credit patient, clerk will prepare bill for each service provided</p>	

B. Admission process

The admission process is related to the inpatient department (IPD) of **Error! Reference source not found.** The admission process consists of various functions required to receive a patient at the hospital facility. The purpose of the process is to obtain required information, determine patient care needs, and put a system into place to address patient care needs. A patient can be received at various levels in the hospital such as at the Emergency Department (EMD), ambulatory surgery, or inpatient hospital level. Nurses will register the patient in the registration books or check from the computer if already registered in the specific ward. She/he will assess the condition of the patient, if there is a need for immediate action the nurse calls the doctor for review. If there is no need for immediate action, the nurse allocates a bed to the patient and continue with other basic interventions before calling a doctor for review. Refer figure 2.3 and table 2.2

Challenges

- *Failure or unwillingness to pay bills:* In most hospitals, we observed that admitted patients sometimes fails or become unwilling to pay their bills during discharge. During the issuance of the bills, some of the patients tend to complain that they cannot afford it. As a result they end up requesting exemption or a complete waive of the bills. This creates loopholes for corruption and lead to huge loses of revenues.

Recommended process improvement

- *Making deposit payment:* For inpatient, hospitals are advised to adopt deposit payment approach, where patient are required to pay a given amount of money prior to service delivery. The deposit amount should be set depending on the nature of service to be rendered and the estimated duration of stay.

- *Issuance of provisional bills:* Rather than accumulating patients' bills until the discharge date, we recommend issuance of bills in small time intervals such as after every two to three days

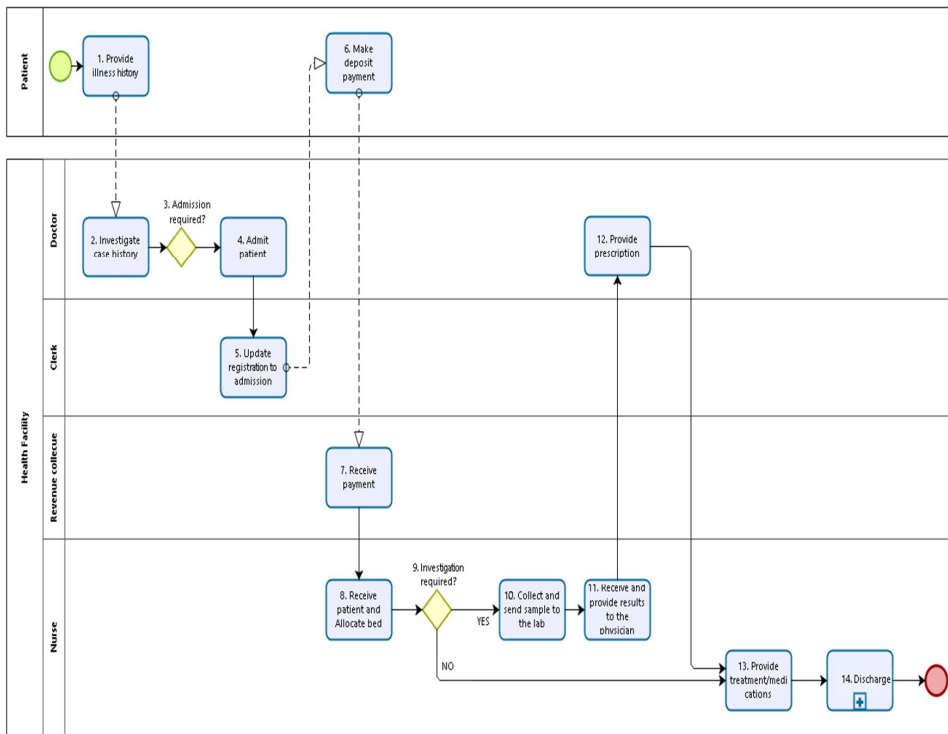

Figure 2.3 : Admission process

Table 2.2: Admission Process/detail

Objective:		
<p>1. Provide illness history Patient meet the doctor provide a detailed history of his/her illness</p>	<p>6. Make deposit payment Cash patient are required to make deposit payment on the estimated cost established by the Hospital policy. Otherwise for insurance or credit patient, the clerk issue bills for the service rendered.</p>	<p>11. Receive and provide the test result to the physician The nurse receives the results of the test and makes them available to the doctor.</p>
<p>2. Investigate case history Doctor records detailed medical history background, observes the vital signs and requests different investigations depending on the diagnosis. Doctor receives the results and plan for treatment. Also, decision is made based on the findings. Patient may be instructed to</p>	<p>7. Receive payment Revenue collector receives the payment and issue receipt to the patient.</p>	<p>12. Provide treatment/administer medication The doctor receives tests results, plans the medication to be administered to the patient. S Nurse receives medication plans from the doctor for execution.</p>

<p>take appointment and continue with treatment at home.</p>		
<p>3. Admission Required? If required, patient is advised for admission in the hospital.</p>	<p>8. Receive patient and allocate bed When the patient arrives at the ward, a nurse receives the patient and assigns him/her a bed. The patient is then checked by the ward doctor, which involves taking/reviewing the detailed medical history and ordering for tests if necessary.</p>	<p>13. Discharge Before leaving the ward, patient is handed over with detailed discharge summary, which includes doctor's advice on their further follow-up treatment and medical description. However, patient must settle the outstanding bills/charges before being handed the discharge summary. The doctor may give appointment for follow-up at outpatient clinic.</p>
<p>4. Admit patient In case of admission, the patient is given the admission date and admission form is filled for further formalities</p>	<p>9. Investigation required? The ward nurse liaises with billing section to get the cost and inform the relatives to pay. In some hospitals investigation bills are issued after service delivery.</p>	

<p>5. Update registration to admission</p> <p>Before admission, the patient is registered as admission and is counseled by the clerk regarding the treatment package, which includes estimated bill size, average length of stay, various mode of payment accepted.</p>	<p>10. Perform the required investigation/test</p> <p>If investigation/test is required and bill procedure completed, nurse collects samples for testing</p>	
--	---	--

C. Laboratory Processes

Laboratory testing and services have an important role in the provision of health care services. The activities of the laboratory process includes: test ordering, patient identification and specimen collection, specimen identification, preparation and transport, analysis, result reporting and interpretation and ensuing action. Refer table 2.3.

Challenges

- During the feasibility study, it was observed that laboratory or radiology machines may be used to perform tests and print results for tests which have not passed through proper billing channel. A lot of revenue may be lost through this avenue.
- It was further observed that sometimes patients may make payments for tests or book for investigations, which may not be currently available for reasons such as no reagents, machines out of order or under maintenance.
- It is difficult for doctors/nurses to track the progress status of samples or investigations sent to laboratory or radiology. The results may be ready

but delivery/distribution depends on individuals who may not be as effective and efficient as needed.

Recommended process improvement

- The laboratory machines should be integrated with iHMS such that only already billed or paid for samples appear on the machine software for testing. This ensure that Laboratory technicians attend to the only billed or paid for samples. The integration will remove the loopholes and increase revenue to the Hospital.
- The laboratory technician should be given an option in the iHMS to disable temporarily all the tests which may not be available due to reasons such as no reagents, machines out of order or under maintenance. This will alert the revenue clerk through warning messages.
- With iHMS, doctors/nurses will be able to track progress status of samples/investigations sent to the laboratory or radiology section. Doctors/nurses do not need to wait for laboratory technicians to manually deliver results that are ready.

Table 2.3: Laboratory business process detail

Objective:		
<p>1. Order booking.</p> <p>The order booking process begins with a request for investigations by doctors. Patientsq information and test requests are recorded in request forms and passed on to phlebotomists to collect samples from patients.</p>	<p>3.Sample receiving and acceptance</p> <p>This is a process where samples are received and accepted for all the orders released. The process laboratory technician checks if the sample is qualified to process. A list of sample orders with the order number, date, time and the patient details verified and recorded.</p>	<p>5. Results reporting</p> <p>The samples qualified are processed. The Laboratory Technician reports the findings for the processed tests.</p>
<p>2. Sample/specimen collection.</p> <p>The activity to collect the booked samples from different booking sources. The samples may be collected by doctors, nurses or Phlebotomist.</p>	<p>4.Sample rejection</p> <p>The samples, which are not qualified, are rejected and returned back to the source. Reasons for rejections may be wrong container, clotted, expired etc.</p>	<p>6. Results approval and delivery</p> <p>Approval of the test results and authorizing for delivery of the report to the patient or the ward/clinic or outside agencies in case some reports belong to the outside agencies.</p>
Objective:		
<p>3. Order booking.</p> <p>The order booking process begins with a request for investigations by doctors. Patientsq information and test requests are recorded</p>	<p>3.Sample receiving and acceptance</p> <p>This is a process where samples are received and accepted for all the</p>	<p>7. Results reporting</p> <p>The samples qualified are processed. The Laboratory</p>

<p>in request forms and passed on to phlebotomists to collect samples from patients.</p>	<p>orders released. The process laboratory technician checks if the sample is qualified to process. A list of sample orders with the order number, date, time and the patient details verified and recorded.</p>	<p>Technician reports the findings for the processed tests.</p>
<p>4. Sample/specimen collection. The activity to collect the booked samples from different booking sources. The samples may be collected by doctors, nurses or Phlebotomist.</p>	<p>4. Sample rejection The samples, which are not qualified, are rejected and returned back to the source. Reasons for rejections may be wrong container, clotted, expired etc.</p>	<p>8. Results approval and delivery Approval of the test results and authorizing for delivery of the report to the patient or the ward/clinic or outside agencies in case some reports belong to the outside agencies.</p>

D. Scheduling Appointment

The scheduling appointment process allows health worker to make patient appointment with preferred date and time to obviate the necessity to sit in queues and wait for the consultation. The patient contacts the Hospital by agreed means of communication; say by telephone, personal contact, email etc., and books an advance appointment with the choice doctor/department on a given date and given slot of time. The consulting doctor also would have the idea of the load on a given day in the hospital. Medical records of the patients visiting the hospital will have to be maintained and updated. Hence the file is handled to and from the consulting room and the medical records Department. Refer table 2.4

Challenge

- **Poor management of patient appointments:** We observed that when doctors issue appointment dates to patients, nurses check the availability of space for that date. When the nurses find out that the clinic is full may be for two to three weeks, they schedule and allocate the patient different nearby date that is vacant, which may not be appropriate depending on the patient's problem. ,

Recommended process improvement

- The appointment should be done by a doctor through the iHMS to make the proper decision of the required dates. Having a different person scheduling the next appointment date for follow up patients may distort the planned treatment of the doctor.

Table 2.4: Appointment business process details

Objective: To ensure proper allocation and management of appointment based on the condition of the patient		
<p>1. Doctor issue appointment date. Doctor after treatment provides the date to revisit the Hospital. The doctor may issue an appointment to the patient on the same or to another clinic based on the case of the patient.</p>	<p>3. Records clerk receive the Hospital card Clerk/nurse receives the appointment card and checks the availability of date issued by the doctor.</p>	<p>5 .Scheduled date not available If the date is not available, the clerk/nurse checks the nearest available date. Clerk/nurse allocates the patient to clinic, doctor and time.</p>
<p>2. Patient present Hospital card Patient submits the card to records clerk.</p>	<p>4.Scheduled Date available If the date is available then clerk/nurse allocates the patient to clinic, doctor and time.</p>	<p>6. Print the appointment slip/write in the hospital card. Record the patient in the clinic appointment register book.</p>

2.3 Pharmacy & Inventory Management Processes

In hospital settings stores and inventory are commonly categorized into general and pharmacy store. The activities performed at the pharmacy store include acquisition, control, management, tracking and dispensing of medicine and medical supplies. Whereas the activities related to the general store involves acquisition, control, management, and tracking of non-medical goods.

While both stores are very important, in this feasibility study report we have mainly focused on the analysis and improvement of pharmacy store. This is because the pharmacy store is an essential and extensively used facility in the hospital and in the health sector in general. It caters to outpatients, inpatients, and other treatment areas like operation theatre, clinical laboratory etc. Therefore the pharmacy store must efficiently be managed and organized to meet patient medication needs and comply with applicable laws and regulations and control medications throughout the hospital.

Following an in-depth analysis of the process as well as discussions with a number of stakeholders from various hospitals, below are the challenges and recommended improvements for the pharmacy and inventory management process. Refer figure 2.4 and table 2.5

Challenges

- **Facilities lack information on available stock at MSD:** At the facility level the eLMIS automate the process of requisition and receiving of medical supplies. However, we observed that the facility is not aware of what medical supplies are available in stock at MSD prior to requisition, as a result, the facility has to issue requisition and wait for the information of missing/available supplies before initiating the process for purchasing from the external suppliers.
- **Medical supplies theft problem:** In most hospitals pharmacy has two main sections, main store and dispensing point. The current setup of most

hospitals, keeps a considerable amount of medicines at the dispensing point. This makes it difficult to control medicines especially when you have several individuals at different shifts using the same facility.

- **Complexity of managing main store:** Stock management is too manual and complex as a result it is difficult to know what is available and the associated expiry dates.

Recommended process improvement:

- **Improve eLMIS:** To avoid the facilities to order supplies which are not available at MSD, eLMIS should be improved to provide access of information on available stock
- **Introduce sub stores:** The purpose of introducing sub stores, in regional referral, zonal referral and national hospitals, is two folds: (1) To reduce and control theft of medical supplies at the dispensing point by reducing amount of medical supplies. (2) To reduce the complexity of managing main stores.
- **Automation of stock management:** Facilities requires automation of stock management at various levels, the main store, sub store, and the dispensing point.

Following the introduction of the sub store section, the pharmacy and inventory business processes can be grouped into three main business processes: (1) Central inventory management process which includes activities ranging from requisition of medical supplies from MSD and other suppliers, receiving, storage, and management (2) Distribution process which includes activities for receiving request from the main store, and dispatch to, dispensing point, (3) Dispensing process that includes activities for delivering medicine to a patient. Below we present the process maps and the descriptions of the activities that reflect recommended improvements.

A. Central pharmacy management process

The central pharmacy management process activities include requisition, purchasing, receiving, checking and storing of medical supplies.

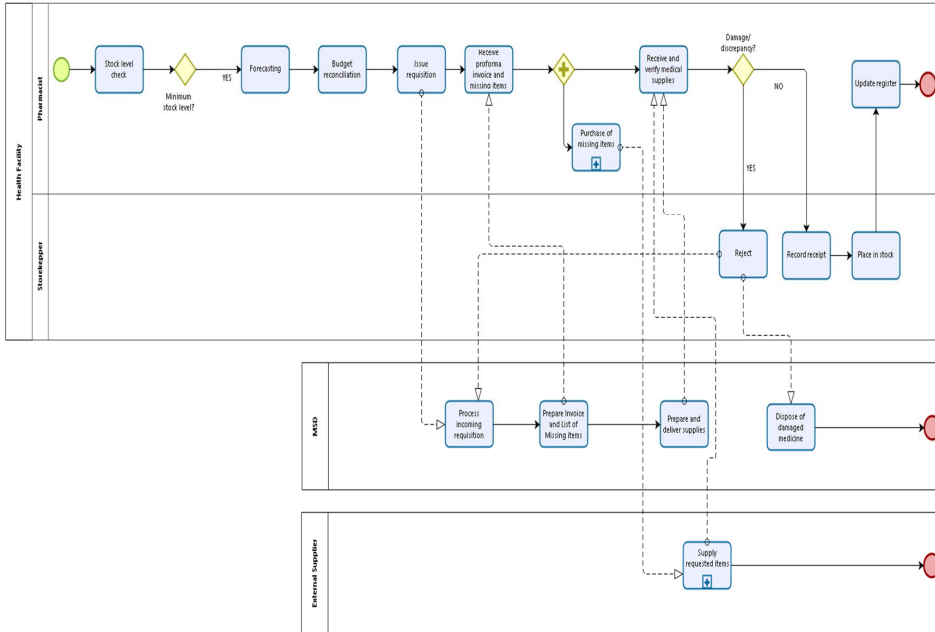

Figure 2.4: Pharmacy & Inventory Management business process

Table 2.5 : Pharmacy & Inventory Management business process

<p>Objective: To ensure the availability of the right medication at the right time, the right dosage, at the minimum possible cost in a proper manner.</p>		
<p>1. Stock level check The pharmacist performs regular stock level check to determine whether medical supplies are to be ordered.</p>	<p>6. Provide proforma invoice and list of missing requested supplies MSD check the requested supplies against the available stock. The proforma invoice is provided for the available supplies along with any missing supplies.</p>	<p>11. Damage/ discrepancy? Check the delivered supplies if there any damage or discrepancy.</p>
<p>2. Forecasting The pharmacist with the support of user departments performs forecasting to aid the requisition/procurement process for ordering adequate stock and securing appropriate cold chain capacity throughout the health system. Forecasting can occur at multiple levels and use different methods of</p>	<p>7. Receive proforma invoice and list of missing supplies The pharmacist receives proforma invoice with quantity and price respectively of available requested supplies, and the list of missed items.</p>	<p>12. Reject the damaged/discrepancy items The pharmacists/inspection team rejects the damaged items. The documentation is done.</p>

<p>estimation. The most common estimation methods include target population estimation, previous consumption estimation, and estimation based on size of planned care service sessions.</p>		
<p>3. Budget reconciliation</p> <p>Provides the mechanism for calculating and ordering goods for stores at intermediate and service delivery points. The process may be performed with a push or pull system. Different rules and guidelines for estimating the need for stock are used to create the requisition. Transmitted requisitions are submitted to the appropriate store and then go through a validation and approval process.</p>	<p>8. Procurement of missing supplies</p> <p>The pharmacist in collaboration with procurement unit completes the procurement of missing supplies from external suppliers.</p>	<p>13. Supplier collects back the rejected items</p> <p>The responsibility of supplier to collect the rejected items from Hospital premises.</p>

<p>4. Issue requisition The pharmacist issue requisition based on the estimated need and the available budget</p>	<p>9. Receive and verify medical supplies The pharmacists or inspection team receive and verify medical supplies delivered.</p>	<p>14. Generate the Good Receipt Note The items received and accepted by the pharmacists/inspection team, GRN should be generated for further procedure.</p>
<p>5. Receive and verify supply request MSD receive and verify the request for processing</p>	<p>10. Damage/ discrepancy? Check the delivered supplies if there any damage or discrepancy.</p>	<p>15. Update the updated physical stock. The physical stock should be updated to reflect the received stock in main store.</p>

B. Medical supplies distribution process

The distribution process is triggered by a requisition. Individual requisitions can be received from service delivery locations when a %pull+ system has been implemented or in the case of a %push+ system can be regularly scheduled based on a previously completed distribution plan or standing orders. Allocation of stock for a requisition can depend on stock status within the store, competing needs of other service delivery, consumption patterns, or budgetary status. Refer figure 2.5 and table 2.6

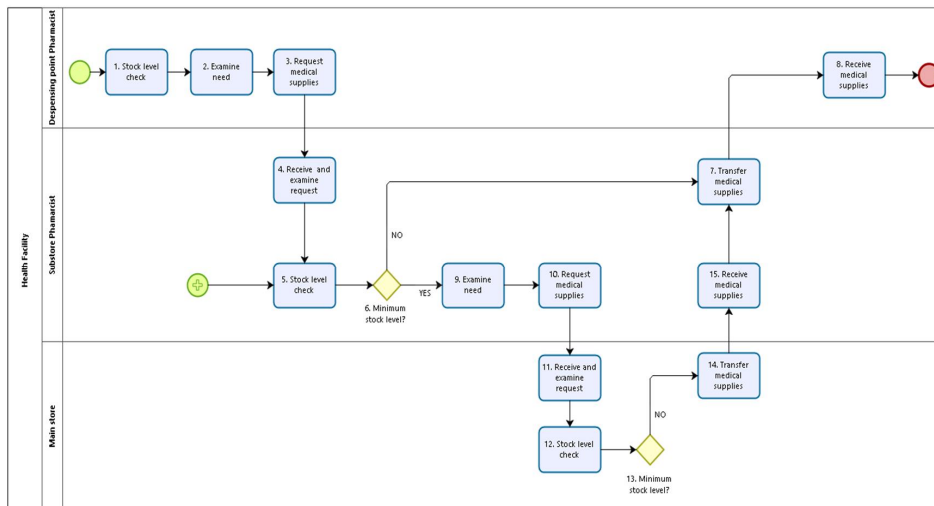

Figure 2.5: Medical supplies distribution process

Table 2.6 Medical supplies distribution process details

<p>Objective. Identify and prepare and deliver accurate quantities of medical supplies packed correctly from store needed at the pharmacy or any service delivery point.</p>		
<p>1. Stock level check Pharmacist/technician at the dispensing point perform a stock level checks</p>	<p>5. Stock level check Pharmacist/technician at the sub store performs a stock level check to determine the availability of the requested medicines. The stock level check is also performed regularly to determine the general need of the sub store.</p>	<p>9. Receive and examine request The pharmacist at the main store receives and examines the request of medical supplies from the sub store.</p>
<p>2. Examine needs Determine medical supplies needed at the dispensing point by calculating required quantities based previous consumptions, hospital guidelines and rules in consideration of minimum and maximum medical supplies stock level at the dispensing point.</p>	<p>6. Transfer medical supplies If the stock is available, the pharmacist at the sub store transfers medical supplies to the dispensing point.</p>	<p>10. Stock level check Pharmacist/technician at the main store performs a stock level check to determine the availability of the requested medicines. The stock level check is also performed regularly to determine the general need of the main store.</p>

<p>3. Request medical supply Issue requisition of medical supplies from the sub store.</p>	<p>7. Examine need If the stock is equal to minimum, the pharmacist at the sub store examines the need for requisition from the main store.</p>	<p>11. Transfer medical supplies If the stock available, the pharmacist at the main store will transfer medical supplies to the sub store.</p>
<p>4. Receive and examine request The pharmacist at the sub store receives and examines the request of medical supplies from the dispensing point.</p>	<p>8. Request medical supplies The pharmacist issues requisition of medical supplies from main store based on the established need.</p>	

C. Dispensing process

The dispensing business process is a high-level and generic process designed to cover the full spectrum of health-related products including medicines, vaccines and other medical supplies. Dispensing begins with a client encounter and a determination of the type(s) of medication which the individual needs. If the medicines are available and in the correct quantity and quality, they will be dispensed to the individual and the client's record will be updated with appropriate information. This business process may trigger a scheduling process to inform the client of their next visit. Refer figure 2.6 and table 2.7.

Challenge

- **Doctors lack information on available medicine:** In most hospitals doctors issue medical prescription to patient without a clear knowledge of what medicines are available in the stock. This may result into repeated prescription, which is costly to both patient and doctors. To overcome this some hospitals have tried to regularly print and disseminate the information of available stock on weekly basis, however it is evident that the exercise is not consistent and it is difficult to establish such information.
- There is a challenge for pharmacists to review/comment on manual prescriptions system.

Recommended process improvement

- Use of iHMS to make information of available medicines accessible to doctors during prescription to eliminate patient movement and repeat of prescription for missing medicines
- Enable online prescription verification by pharmacist to eliminate patient/pharmacist movement and queues to the pharmacist

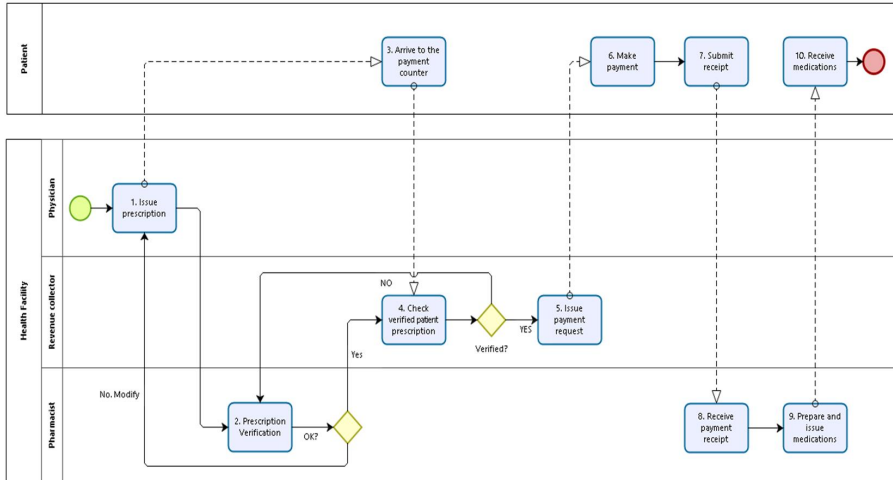

Figure 2.6: Dispensing process detail

Table 2.7: Dispensing process detail

Objective: Effective dispensing right quantity and quality of medicine to the right client with right information for proper use		
<p>1. Issue prescription Doctor examines the patient and issue prescription for medication. The verification request is sent to the pharmacist for approval.</p>	<p>4. Check verified patient prescription Upon arrival of the patient at the payment counter, the revenue collector checks in the system to determine if pharmacist has passed/verified the prescription.</p>	<p>8. Receive payment receipt Pharmacist receives the payment receipt before issuing medicine</p>
<p>2. Prescription verification</p>	<p>5. Issue payment request</p>	<p>9. Prepare and issue medication</p>

Pharmacist receives, review and approve the verification request through online systems. Otherwise request is sent back to doctor for modification.	The revenue collector issues the payment request for passed/verified prescription.	The pharmacist prepares medicine as per doctor prescription and issue to patient. Give the patient right information on how to use the medication.
3. Patient arrives at the payment counter Patient arrives at payment counter to get medicine after the issuance of the prescription by the doctor.	6. Make payment Patient make payment and receive receipt for the medicines	10. Receive medication Patient receives the medication and instructions from pharmacist.
	7. Submit receipt Patient submits receipt to pharmacist for verification before issuing the medicine.	

2.4 Patient Billing Process

Hospital billing is a process to obtain payments for services and items rendered by the hospital. The hospital billing process begins when a patient arrives at the hospital for diagnosis and treatment of injury, illness, diseases, or any other health condition. Patient care services and items provided during the patient stay are recorded on the patients account. Charges are posted to patients account by various departments. When patient leaves the hospital, all information and charges are prepared for billing. Refer figure 2.7 and table 2.8.

Challenges

- *Cash theft problem:* Payment through cash creates loopholes for patients to pay for services in the wrong hands/pockets. The cash payment tempts health workers to collect cash in the corridors and make loss of revenue to run the hospital.
- *Lack of a standardized credit company claim form:* We have observed that each credit company has a different claim form which has to be filled by healthcare providers. With a hospital receiving patients who are members of a number of credit companies, processing these various unstandardized claim forms is a cumbersome exercise.
- *Difficulties in differentiating between services covered and those that are not covered by the credit companies:* The mechanism to detect the services that are covered and those that are not covered by a particular credit company during service care delivery is very cumbersome. For instance, one hospital may render services that are not covered say by a certain credit company but during claim processing, the credit company rejects. This lead to a lot of revenue loses to the hospitals.

Recommended process improvement

- Payment for services can be done directly through the bank, as it is being done in some hospitals such as the Muhimbili National Hospital (MNH).
- Standardize the claim forms for the credit companies.
- Enable electronic detection of the services covered and those that are not by the credit companies during patient care delivery.

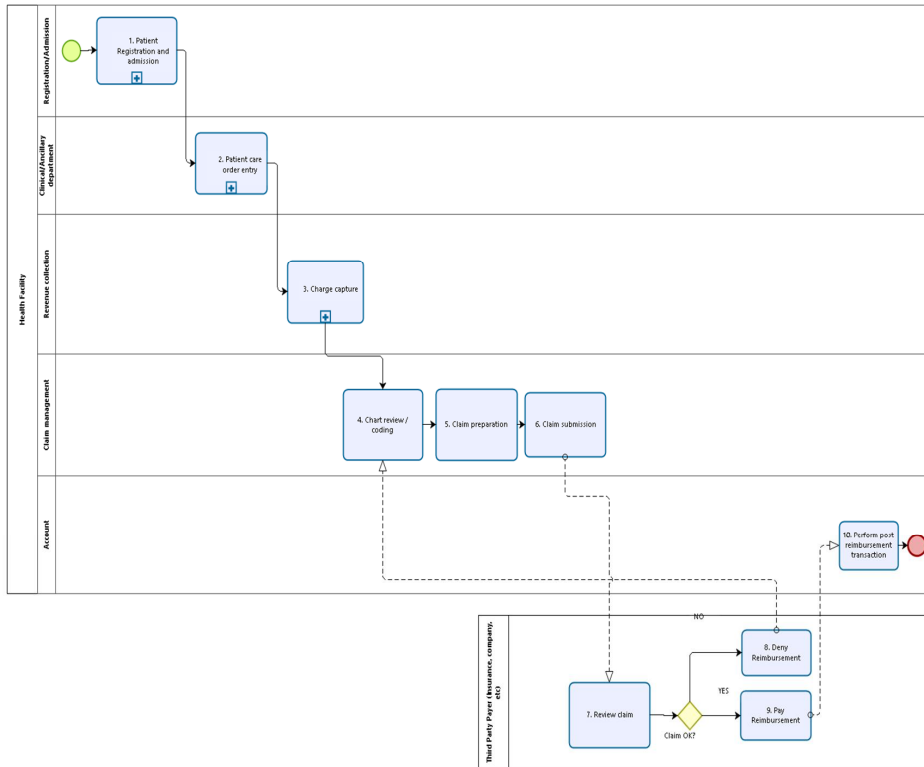

Figure 2.7: Patient Registration and admission process

Table 2.8: Patient Registration and admission process

Objective: To ensure services rendered in a health facility are properly charged to recover the incurred costs		
<p>1. Patient registration and admission</p> <p>Patient is received at the hospital in an outpatient or inpatient basis. Non-patient services may be provided when the specimen is received for processing and</p>	<p>4. Chart review and coding</p> <p>The patient is released from the hospital when attending physician provides a written discharge orders and instructions. Once the patient is discharged the completed medical record, is forwarded</p>	<p>7. Bill payment</p> <p>Patient payments are posted and balance owed are printed on a statement and sent to the patient until the balance</p>

<p>patient is not present.</p>	<p>for coding and review of patient's medical record to identify and verify charges.</p>	<p>is paid. Claim received by payers (i.e. Credit company) is processed after review is performed. Payment determination is conducted by the payers after claim review is performed which can results in one of the following: claim may be paid, or pended, or denied.</p>
<p>2. Patient care order entry Patient care services are rendered in accordance with physician's order. The physician's order are entered in hospital's information system and distributed to the appropriate department.</p>	<p>5. Charge/Claim preparation The claim management unit utilizes information gathered during the patient stay to prepare appropriate documents required for charge or claim submission. Patient invoice or statement is utilized to submit charges to the patient. Claim forms are utilized to submit charges to the third-party payer (i.e.</p>	<p>8. Post payment transaction Patient payments are posted and balance owed are printed on a statement and sent to the patient until the balance is paid. Claim received by payers (i.e.</p>

	Credit company such as NHIF, AAR etc.).	insurance) are processed after review are performed. Payment determination is conducted by the payers after claim review are performed which can results in one of the following: claim may be paid, or pended, or denied.
<p>3. Charge capture All services and items provided during patient's stay are documented in the patient's record. All departments, including pharmacy and sterile supplies, involved in providing patient care are responsible for posting charges to the patient's account.</p>	<p>6. Charge/Claim submission The claim management unit utilizes information gathered during the patient stay to prepare appropriate documents required for charge or claim submission. Patient invoice or statement is utilized to submit charges to the patient. Claim forms are utilized to submit charges to the third-party payer (i.e. Credit company).</p>	

2.5 Account, Financial and Human Resource Management

The back office processes in the hospital business process framework (figure 2.1), which include accounts, finance, procurement and human resources management, like in any other industries are conducted guided by standardized procedures such as financial regulations, public procurement regulations, etc. The analysis of these processes indicated no challenges, except for human resource management and account receivable management. Hence improvement of the efficiency of most of the back office processes should be guided by the standardized procedures and regulations governed by their bodies such as PPRA, NBAA etc.

A. Account Receivable Management Process

Account receivable (A/R) is a term used to describe revenue owed to the hospital by patients and third-party payers. Account receivable management is a process of monitoring and follow-up on outstanding accounts. Outstanding accounts are the accounts that have been billed to the patient or third party payer but have not yet been settled. Refer table 2.9

Challenge:

- *Lack of proper mechanisms to identify and secure outstanding claims:*
There is a challenge to set agreement with credit companies that; payment should be within range of time and suspension of service clause.

Recommended process improvement

- Close follow up with Credit Company will assist to obtain bills, which need corrections on time.
- Receiving payment on time will assist hospital supplies consistency.

Table 2.9: Patient outstanding account process details

Objective: To minimize the amount of time that accounts are outstanding		
<p>1. Identify outstanding patient accounts / claims</p> <p>Perform monitoring and review to identify accounts that have not been paid by utilizing various reports such as unbilled account report, financial class report, denial management report, and account receivable aging report.</p>	<p>2. Assessing action required to secure payment</p> <p>Write a reminder letter to the credit company with a warning to suspend the service to their members.</p>	<p>3. Implement procedure to secure payment</p> <p>Receive payment from the credit company. If no payment suspend services to credit company members, with a suspension letter sent to the company.</p>

B. Human Resource Management

An in depth analysis of the human resource management (HRM) in the hospital settings revealed one major challenge on controlling the health workers to ensure they effectively work to deliver health care services according to their contracts. This challenge can partly be addressed by establishing proper control such as roster management and biometric solutions to identify employees as they arrive and leave the hospital.

In the course of the feasibility study we found out that there some existing electronic HRM systems that are being used by the MoHSW, the Human Capital Management System (HCMS) and the Human Resource for Health Information System (HRHIS). HCMS is a centralized human resource management tool which caters for all cadres and all ministries including the MoHSW, managed by UTUMISHI. The system keeps an updated list of government employees and management of issues related to their salaries. It does not cater for HRM activities at the facility level such as roster management, leave management, employees on study management, etc. Conversely, HRHIS is a centralized HRM tool under the MoHSW that caters for health cadres only. Likewise the system keeps an updated list of all healthcare employees but like the HCMS, it does not cater for routine HRM activities at the facility.

3. Functional Requirements for iHMS

The requirements for the Hospital Management System (HMS) are designed for multispecialty hospitals, to cover a wide range of hospital administration and management processes. It is an integrated end-to-end Hospital Management System that provides relevant information across the hospital to support effective decision making for patient care, hospital administration and critical financial accounting, in a seamless manner.

3.1 High level Requirement Summary

In this section we present a high level requirement summary to give the reader a general picture and a snapshot of what is entailed in the iHMS.

i. Patient Care Management

The system should provide functionalities that capture the complete and relevant patient information. It should automate the patient administration functions to give a better and efficient patient care process. It should answer all enquiries about the patient which include admission, appointment scheduling and discharge details.

ii. Laboratory

The system should automate the investigation request and the process involved in delivering the results to the concerned department/doctor of the hospital. The system should start by receiving online requests from doctors and also allow laboratory personnel to generate requests. It should support performance of various tests under the following disciplines: Biochemistry, Cytology, Hematology, Microbiology, and Serology. Tests should be grouped under various sections and sample type (specimen). Based on the request the user can input the sample and generate the sample number. Results can be entered based on the sample type either to one test or multiple tests. If the test result requires approval, the supervisor has to approve the result and make it available to concerned doctors.

iii. Billing

The system should provide functionalities related to billing the patient for all the services taken by him in the hospital. The patient should be billed according to business rules of the hospital, which should be maintained and validated by the system.

iv. Pharmacy and Inventory Management

The system should provide functionalities for requisition of medical supplies, purchase of items, issuance of items, stock management, automatic reorder level setting, online request for stock from main store to various sub-stores and dispensing points, management of stock at different categories such as physical stock verification and adjustment, return of medical supplies to supplier etc. The system should be able to receive prescriptions from the consulting doctors and reflect automatically into dispensing unit and payment counter of a respective patient.

v. Medical Record Management

The system should be able to maintain the core information on clinical care. A complete standard International Classification Diagnosis (ICD) should be used to build up the data for medical records. It should be possible to maintain diagnosis, treatment advised and surgery/treatment details in the record. The iHMS should provide two levels of medical records: One should have the basic data and the other level should have the detailed records of surgery, diagnosis etc. As part of the medical records, it should be able to store image outputs from any equipment.

vi. Human Resource Management

The system should track and manage all the human resourcing activities with respect to the Personal and Payroll functions. It should provide functionality related to employee management, directory management, leave management, roaster management etc. It should be possible for the system

to be integrated with biometric solutions to identify employees as they arrive and leave the hospital premises.

vii. Management Information System (MIS)

The system should provide managers with a dashboard that offers a real-time, at-a-glance personalized information related to various activities. It should be able to dig deep in the system and come up with real-time reports to support immediate decision making.

viii. Financial Management

The system should cater the entire range of accounting activities that is conducted in a typical hospital setting. Right from the time the patient walks in to the time the organization presents its profit and loss accounts. From every transactional point of hospital like pharmacy, canteen, blood bank, OT, maintenance etc.

ix. Integration and Information Exchange

The iHMS should be able to be interfaced seamlessly with third party systems and devices like Lab Devices, SMS integration, PACS, Finance etc. It should have the capability to share (transmit and receive) a defined minimum set of data with other systems.

x. Security and Confidentiality

The system should provide security and confidentiality of health data to ensure that the privacy of patient data and other related information is maintained.

4.1 Detailed Functional Requirements

4.1 Patient Care Management

Section	User/Functional Requirements	Priority
1.0	GENERAL	
1.1	The system should handle all the admission, transfer and discharge operations for the hospital. It should allow for a complete registration for a patient, or a quick registration for rapid registration at the Ambulatory & Emergency Department.	Must
1.2	System should generate a sequential Medical Record Number (MRN) for each new patient registration.	Must
1.3	MRN should be unique for each patient, and to be carried by the patient throughout the life of the hospital.	Must
1.4	System generated sequential Account Number should be generated for each new patient visit.	Must
1.5	Account Number should be unique for each visit, and should be used for all billing purposes.	Must
1.6	The system should have the ability to capture billing and insurance payment details to enable bills to be sent to correct payer.	Must
1.7	The system should have the ability to make certain fields mandatory during the registration process	Should
2.0	ADMISSIONS / REGISTRATIONS (A&E)	
2.1	All admissions must be performed through a registration function (inpatient, outpatient, A&E).	Must
2.2	The system should have the ability to carry out a quick registration with minimal mandatory registration information process, e.g. for the A&E Department	Must
2.3	System should be able to flash alert to Registration Clerk if patient has any outstanding bills	Must
2.4	The system should have the ability to capture insurance and	Must

Section	User/Functional Requirements	Priority
	billing information at admission/registration time. These details will include whether the patient should be billed or not, Guarantee Letter information, Third Party Payer/ Insurance information etc.	
2.5	If billing is applicable, the system should automatically determine the consultation charges applicable based on the billing rules, to determine the applicable charge, and to enable the charges to be collected prior to the consultation.	Must
3.0	NEW BORN ADMISSIONS	
3.1	Newborn admissions must be based on mother-baby link, ie admission details to be based on mother's admission record.	Should
4.0	BED BOARD MANAGEMENT	
4.1	Online, real time bed availability status by Ward / Department hospital wide	Should
4.2	Ability to search for beds by ward	Must
4.3	Ability to search for beds by bed class, within the ward	Must
4.4	Ability to search for beds by bed class, throughout the hospital facility	Must
4.5	Ability to create dummy beds which can be used for admission when all beds in ward are occupied, but pending discharges. These beds are not to be included in the census count.	Should
5.0	TRANSFERS	
5.1	Can be effected between beds in the same ward or between wards	
5.2	System to chronologically sequence each transfer and keep track of patient's movement history.	Must
6.0	DISCHARGES	
6.1	Ability for system to check that all formalities have been completed and to trigger warnings otherwise.	Must
6.2	If a patient has to be billed (ie a patient without a Guarantee Letter), the system will check that a Discharge Bill has been	Must

Section	User/Functional Requirements	Priority
	generated, otherwise the discharge is not to be effected.	
7.0	MASTER CODES	
7.1	The system must have a provision to set Master Codes	Must
7.2	The sex of the patients to be admitted into the ward has to be coded, and the system will validate this during the admission process.	Must
7.3	Rooms within Wards : all rooms within the ward will be codified	Should
7.4	Beds for Wards : all beds within the ward will be codified, according to bed class	Should
7.5	Type of Ward : specifies classification of ward	Must
7.6	Bed Class : specifies classification of beds, and should be used to set up entitlements	Should
7.7	Admission Type : specifies the nature of admission	Must
7.8	Transfer Type : specifies the nature of transfer	Must
8.0	QUERIES & REPORTS	
8.2	Bed Occupation Inquiry: Ability to display on-line, the status of each bed in any ward, with details of patient occupying the bed.	Should
8.2	Hospital Bed Status Inquiry: Ability to display on-line, the total bed complement within the hospital with details of the number of beds occupied and free in each ward.	Must
8.3	Patient Movement History : Ability to display on-line the details of patient Admission Discharge and Transfer for each patient	Must
8.4	Inpatient lists : Reports of all inpatients in all wards, sorted by ward, by admission date, by admitting doctor, by patient name, by sex etc.	Must
8.5	List of Admissions : Reports on all patients admitted, with full admission details, sorted by Admission Date, Ward, Admitting Doctor	Must
8.6	Admission Discharge and Transfer statistics such as Admissions by admission types, Admissions by medical specialty, Transfers	Should

Section	User/Functional Requirements	Priority
	by transfer type, Discharges by discharge type	
9.0	BED CHARGES	
9.1	Calculation of bed charges based on number of days stayed	Must
9.2	Calculation of bed charges based on financial class of patient	Should
9.3	Calculation of bed charges based on bed type	Should
9.4	Automatic calculation of bed charge if the bed is occupied for more than a pre-defined number of days	Should

4.2 Laboratory

Section	Functional Description	Priority
1.0	GENERAL	
1.1	The system will be used in the AP Section of the Main Laboratory, serving the needs of the Inpatients, Outpatients, Emergency Departments, and Operating Theaters.	Must
2.0	Charging	
2.1	To create a charge in the patient's bill for any procedure that is carried out.	Must
2.2	There should be flexibility to determine at which point the patient will be charged for the procedure. For example, for Test A, the patient could be charged at the point the test is ordered, while he could be charged only when the procedure has been reported for Test B, or when the procedure has been completed for Test C.	Should
2.3	There will be an option for a supervisor to reverse a charge if required.	Must
3.0	Queries and Reports	
3.1	Inquiries by	Must

Section	Functional Description	Priority
	Patient name or MRN, Accession number, Physician, Source (ward / clinic / department), Test Charges collected department wise lab wise.	
3.2	There must be an option for supervisor to reverse a charge if required	Must

Order Management

Section	Functional Description	Priority
1.0	GENERAL	
1.1	The Order Management application addresses the order entry, order review and/or validation, It is envisioned that orders can be placed for any ancillary department by any user in the hospital, depending on the security level assigned to him	Must
2.0	Order Entry	
2.1	The order entry process can be decentralized, ie an order can be placed from any PC within the hospital.	Must
2.2	The system will be able to handle the following order types : single order, multi-departmental orders.	Should
2.3	Users should be able to place any type of order, clinical or non-clinical, from one application.	Must
2.4	Each order type must have its own set of pre-determined data fields.	Must
2.5	There is an option to identify the urgency of an order.	Should
2.6	There is an option to cancel or Modify an order if it has not been processed yet.	Should
3.0	Order Processing	
3.1	The status of any order will be updated automatically, real-time, by the system to enable users to have an online review of the status of any order for any patient.	Must
4.0	Order Inquiry	

Section	Functional Description	Priority
4.1	Users can review the status of any order online from anywhere within the hospital.	Should
4.2	Users restricted to viewing information only on those patients in their assigned locations.	Must
6.0	Charging	
6.1	The system creates a charge in the patient's bill for any procedure that is carried out.	Must
6.2	There will be flexibility to determine at which point the patient will be charged for the procedure. For example, for Test A, the patient could be charged at the point the test is ordered, while he could be charged only when the procedure has been reported for Test B, or when the procedure has been completed for Test C.	Must
7.0	Queries and Reports	
7.1	On-line status inquiry of requests	Must
7.2	On-line charges inquiry	must

Operation Theatre Management

Section	Functional Description	Priority
1.0	GENERAL	
1.1	The Operating Theatre (OT) Management application will provide all functions required for charging of the Operating Theatres of the hospitals.	Must
2.0	Charging	
2.1	There will be an option for users to charge by exception.	Must
2.2	The system automatically creates a charge in the patient's bill for any procedure that is carried out.	Should
2.3	There will be an option for a supervisor to reverse a charge if required.	should
3.0	Queries and Reports	

Section	Functional Description	Priority
3.1	Exception Reports for the following:	
3.1.1	Surgeries not yet Charged	Must
3.1.2	Surgeries completed but charging not done.	Must

4.3 Billing Business Process

For the Patient Billing process should provide functionalities related to billing the patient for all the services taken by him in the hospital. The patient should be billed according to business rules of the hospital, which are maintained and validated from this module. The following table describes the functionalities in broad terms that are required of the billing process.

Section	Functional Description	Priority
1.0	GENERAL	
1.1	The system must provide the hospital with a comprehensive facility to track all charges for a patient from the point of registration to the stage of discharge / completion of a visit.	Must
1.2	The billing process must be flexible so that it can be done for inpatients at pre-defined periods or at end of the episode, while for outpatients it can be done at each service point (either at the point the order is placed or at the point it is completed), or at the end of the visit.	Must
1.3	This system must be fully integrated system so that billing transactions can be automatically posted to the patient's account from the laboratory, radiology, operation theatres, pharmacy, wards/clinics and so on.	Must
1.4	Patient Billing must also be integrated with Accounts Receivable for managing credit patients.	Must
1.5	The benefits envisaged through the implementation of an integrated or tightly interfaced Patient Billing System include	Must

Section	Functional Description	Priority
	<p>Automatic, real-time build-up of patient's service charge profile.</p> <p>Billing can be done at short notice</p> <p>Instantaneous availability of patient-dues, various service charges etc.</p> <p>Enables analysis of the hospital's income through various services.</p> <p>Saves the Accounts department a lot of time and effort that would otherwise be spent on tracking patient charges.</p> <p>Facilitates effective control and monitoring of receivables.</p>	
2.0	Billing Groups	
2.1	The system must be able to classify patients into various Billing Groups in order to group patients into various paying categories.	Must
2.2	The system must be able to capture various paying categories including but not limited to non-paying / individuals paying cash / individuals with credit facility / sponsored patients (sponsored by insurance company, employer etc.) with credit facility.	Must
3.0	Billing Classes	
3.1	System must be able to allow users to define various classes of service rendered in user-defined terms as say, first class single bed / first class double bed/ second class bed / ordinary class bed / etc	Must
3.2	Billing classes will be determined and entered into the system at registration time.	Must
4.0	Bed Charges	
4.1	The system should provide flexibility in defining bed charges	Should

Section	Functional Description	Priority
	depending on the type of ward / room / bed	
4.2	If the patient occupies beds of differing classes on the same day, the bed, which has the higher daily bed charge, will be selected for billing.	Should
5.0	Bills	
5.1	System must have flexibility to print inpatient bills periodically for all inpatients or individually at the end of the inpatient episode.	Must
5.2	The system must have flexibility to print interim bills for inpatients	Must
5.3	The system must have flexibility to print outpatient bills at each service point, at the point that the service is provided or consolidated at the end of the outpatient visit.	Must
5.4	The system must be able to automatically calculate all relevant government service taxes and add it to the bill.	Must
6.0	Cashiering Functions	
6.1	There must be provision to identify the Cashier Counter during cashier operations to ensure accountability of all transactions processed. This will also record the cashier identifications such as his user id, which is unique within the system.	Must
6.2	The system must have facility to process various kinds of receipts, for example, Collection against a bill Collection against an account receivable for patients with credit facility Collection of a deposit Collection of a pre-payment	Must

Section	Functional Description	Priority
	etc.	
6.3	The system must have facility to process various kinds of refunds, for example, Refund against a bill Refund of a deposit etc.	Must
6.4	Ability to print receipts / refund documents on pre-printed stationery in on-line mode or batch mode	Must
6.5	All receipts and refund documents must be customizable by the users	Must
6.6	System must support various types of receipt printing based on visit type, for example, a different receipt is required for an emergency visit as compared to an Outpatient visit or Inpatient visit.	Must
6.7	Receipts must have system generated sequential numbers, the format of which will be user-defined.	Must
7.0	Queries and Reports	
7.1	Inquiry on Patient Details	Must
7.2	Inquiry on Patient Charge Profile	Must
7.3	Inquiry on account status	Must
7.4	List of Receipts	Must
7.5	List of Third Party Payer Bills, to be printed on a pre-defined schedule	Must
7.6	List of discharges to reconcile with bills	Must
7.7	Inpatient bills in detail as well as summary	Must
7.8	Inquiry on patient financial details by Patient name Account number	Must
7.9	Inquiry on any transactions recorded In an account	Must

Section	Functional Description	Priority
7.10	Inquiry in patient's current charges and outstanding status	Must
7.11	Top up reports for patients whose current charges have exceeded the deposit paid	Must

4.4 Pharmacy and Inventory Business Process

Section	User/Functional Requirements	Priority
	STOCK CONTROL	
1.1	The pharmacist may set the stock levels required by the hospital to maintain one or more pharmacy outlets within the hospital.	Must
1.2	The stocks can be replenished by a process or manually triggered by the person responsible.	Must
1.3	Automatically generate reorder documents for the procurement of new stock.	Must
1.4	The system will also facilitate manual entry of requisitions from the various wards/clinics/departments in the hospital.	Must
1.5	Expiry and non-expiry items must be supported. For expiry items stock is maintained at batch level with expiry date for each batch; and any store transaction must identify the batches being processed as part of the transaction.	Must
1.6	Facility to maintain preparation details and constituent items for manufacturing items. Manufacturing receipts use this information to receive the prepared item into stock and reduce stock from the constituents that have been used. Plus minus variation limits can be set on usage of constituents.	Must
1.7	Facility to record transfers between main stores, sub stores and dispensing points.	Must

Section	User/Functional Requirements	Priority
1.8	Stock balance must be updated immediately on confirming a transaction (receipt of stock into inventory, returns to vendors, dispensing to patients) to reflect true on-hand status at any time.	Must
1.9	Automatic validation and warning on expiry of items.	Must
1.10	Provision to remove expired items from active stock to be replaced or destroyed.	Must
1.11	Provision for recording physical stock check figures and generating variance reports and automatic adjustments. There must be a facility to use hand held devices for stock checks where inventory information can be downloaded to the device at the start of the stock take, and then uploaded back into the main system at the end of the day.	Must
1.12	Mandatory entry of reason in adjustments for audit purposes.	Must
1.13	Stock transactions effect on financial accounts need to be reflected in the General Ledger based on the accounting linkages.	Must
1.14	Provision to close each accounting month after all transactions have been recorded for that month.	Must
1.15	Outgoing medicines and prescriptions are automatically deducted from its stock list.	Must
1.16	For each item-store combination, the minimum/maximum quantities and re-order quantities are maintained depending on the policies and procedures adopted for replenishment of stock at the sub-stores and non-stock stores.	Must
1.17	As the inventory levels reach reorder points, the system will automatically generate purchase orders for reordering by comparing the stock-on-hand with the reorder level. The orders must be reconciled upon delivery.	Must

Section	User/Functional Requirements	Priority
2.0	MEDICATION ORDERS	
2.1	Medication orders can be entered for inpatients who are identified by their financial numbers so that medications can be connected to each term of stay separately.	Must
2.2	The drug item codes will be easily and quickly retrieved by mnemonic, trade or generic name search.	Must
2.3	The system will allow order entry in centralized or decentralized locations throughout the hospital, by various categories of staff such as physicians, nurses, clerks or technicians.	Must
2.4	Pharmacist verification, if required, will be quickly and efficiently entered or modified for conditional medication orders. Clinical alert warnings may be delayed until the pharmacist verification step or may appear during non-pharmacist order entry. In all cases, clinical warnings, including user actions, must be recorded for action and review at a later time.	Must
2.5	Master Codes . the following Master Codes must be set up within the system :	
2.5.1	Drug Forms: Code and description for the various forms in which drugs are Available.	Must
2.5.2	Route of Administration: Code and description for the different methods in which a drug can be administered, e.g. Intravenous, Oral.	Must
2.5.3	Instructions for Administration: Code and description for brief instructions on the method of administering a drug to patients.	Must
2.6	The system must enable users to enter all medications into the system from the same screen. Medications can be	Must

Section	User/Functional Requirements	Priority
	selected by mnemonic, brand name, generic name, therapeutic category, or product codes.	
2.7	Common order entry sets should be defined to further expedite the order entry process by having the most commonly used items pre-selected for activation and the less customary items Available for activation.	Must
2.8	If there have been medication orders earlier for the same inpatient, then medications issued to the patient must be checked for inclusion of these drugs and warnings issued where appropriate	Must
2.9	For controlled drugs, a supervisor must authorize the issue before the transaction can be processed.	Must
2.10	The system must have provision for returns against prescriptions	Must
2.11	The system must provide support for all medication orders, processing, administration, and dispensing in a paperless environment.	Must
3.0	QUERIES AND REPORTS	
3.1	Drug formulary inquiry by code, trade name and generic name.	
3.2	Inquiry on drug interactions.	Must
3.3	Inquiry on patient's total drug profile (all medications and prescriptions to date).	Must
3.4	List of inpatient medication orders by patient, ward and doctor.	Must
3.5	Details listed will include the financial number and MRN of the patient, patient name, prescription number and date, drug code and name, start date for the medication, period, dosage, doctor's identity, quantity of the drug prescribed and	Must

Section	User/Functional Requirements	Priority
	whether the order is a one-time or repeating prescription.	
3.6	List of outpatient prescriptions by patient, clinic and doctor.	Must
3.6.1	List of Repeating Orders for a given drug store/pharmacy and for a specified range of dates.	Must
3.7	Controlled drug register	Must
3.8	List of discontinued drugs	Must
3.9	Stock status report	Must
3.10	Stock ledger	Must
3.11	Stock Analysis reports on fast moving items, slow moving items and non-moving items.	Must
3.12	Consumption statement by item and by ward/clinic/department.	Must
3.13	Valuation statements by costing units	Must
3.14	Expiration list by period	Must
3.15	Items to be re-ordered	Must
3.16	Items above maximum stock levels	Must
3.17	Daily transaction details report	Must
3.18	On-line stock status inquiry by item for all stores in the hospital and by store for all items in that store.	Must
3.19	Inquiry on stock transactions for an item.	Must

Section	Functional Description	Priority
1.0	GENERAL	
1.1	The system must be able to handle on-line data entry	Must
2.0	VENDOR INFORMATION	
2.1	Vendor codes should be alphanumeric.	Should
2.2	The vendor code should be either system generated or manually entered.	Should
2.3	A short name, mnemonic or vendor codes will be used to	Should

Section	Functional Description	Priority
	access vendors during transaction entry and enquiries.	
2.4	The system should cater for the following information on the vendor record:	
	Vendor code, vendor short name, vendor name, vendor address, vendor telephone, vendor facsimile number, vendor contact person, vendor type, optional bank details, optional or user-defined multiple credit terms or contract information, currency details, payment method, credit limit, last date of activity, lead time, history, GL codes for purchases, creditors and cash	Should
2.5	The system should produce a list of vendors with no activity for a specified period of time.	Should
3.0	VOUCHER ENTRY	
3.1	The system should provide:	
	invoice register facilities	Must
	certification of invoice values	Must
3.2	The system should register and certify the invoice at the same time.	Must
3.3	The system should record to whom invoices have been sent for either approval, GL coding or adjustment.	Must
3.4	The system should allow for the following fields in the transaction record: vendor code, vendor reference invoice number, transaction reference for internal use, invoice type, terms, invoice date, invoice receipt date, posting date, due date, period, gross amount, discount, net amount, optional quantity, optional unit price, transaction currency, currency rates, payment method e.g. cheque, bank details, order number and link to order details e.g.. item code, type, order quantity, GL code, hold information - before updating GL, status code -	Must

Section	Functional Description	Priority
	delivered or not, flag prepaid for items	
3.5	The system must check for duplicate vendor invoice numbers.	Must
3.6	There is no limit to the number of lines per invoice.	Should
3.7	General ledger code distributions should be entered on: purchase orders, vendor record, individual lines on an invoice	Must
3.8	General ledger distribution codes should be validated online in the AP and invalid transactions rejected.	Must
3.9	The system must check that the total recorded against the distribution lines equals the total invoice sum.	Must
3.10	The system should be able to handle discounts as either a percentage or an amount.	Should
3.11	The system should automatically post a discount to the correct general ledger account for discounts.	Should
3.12	It should be possible for a group of invoices to be authorized for payment together.	Should
3.13	Matching should be available for both the whole invoice and line by line	Should
3.14	It should be possible to process and authorize a goods received note.	Should
3.15	A credit note can be matched with parts of one invoice	Should
3.16	Amount transactions entered on-line can be posted at the end of the day or period.	Should
3.17	Posting should update the accounts payable, general ledger	Should
4.0	PROCESSING OPTIONS	
4.1	The system should allow processing of more than one accounting period typically previous and future periods.	Should
4.2	The system should handle accruals with automatic reversal in the next period.	Should
4.3	The system accept open item accounting.	Should

Section	Functional Description	Priority
4.4	It should be possible to search using: supplier name, supplier short name, invoice number, invoice reference, purchase order number, cheque number, transaction date	Should
5.0	PAYMENTS	
5.1	It should be possible to process manual cheques and they should appear on the cheque register.	Should
5.2	It should be possible to pay more than one cheque for a vendor.	Should
5.3	It should be possible to stop payment of a specific invoice temporarily.	Should
5.4	It should be possible to make a payment during the same processing cycle that the invoice was entered.	Should
5.5	It should be possible to pay invoices as specified without regard to the payment scheduled date.	Should
5.6	The system should allow for part payments to be made.	Should
5.7	It should be possible for individual items to be paid on the next payment date to be listed in advance of the cheque processing cycle.	Should
5.8	Duplicate payments should be identified.	Should
5.9	Individual general ledger codes should be specified for each bank account.	Should
5.10	The system should be able to handle advance payments.	Should
5.11	The interface with the general ledger should allow the cheque number reference to be passed into the general ledger to assist with bank reconciliations.	Should
5.12	If a posted payment is voided, the GL posting should automatically be reversed.	Should
5.0	PURCHASE ORDER PROCESSING	
6.1	The system should facilitate matching, of purchase orders,	Should

Section	Functional Description	Priority
	receiving reports and vendor invoices.	
6.2	Matching should be available for both the whole invoice and manual matching.	Should
6.3	The system should produce exception reports of unmatched invoices.	Should
7.0	INTERFACES	
7.1	The user should have the option to post to the general ledger: at the detail level and summary level by voucher	Should
7.2	The general ledger should be posted at the same time as the accounts payable subsidiary ledger is posted.	Should
7.3	The system should support interfaces to other systems including: purchasing, receiving, general ledger, stock control	Should
8.0	VENDOR PURCHASE ANALYSIS (REPORTS)	
8.1	There should be a report summarising purchase and payment history by vendor.	Should
8.2	There should be a report listing open items and paid items.	Should
8.3	The system should print vendor statements.	Should
8.4	The system should produce a vendor ledger listing by vendor number and alphabetically	Should
8.5	The system should be able to produce an accounts payable invoice/voucher register.	Should
8.6	The system should produce an aged outstanding balance report by vendor in both detail and summary.	Should
8.9	Aging bands (e.g.. 30,60, 90 days) should be user-specified.	Should
9.0	Queries	Should
9.1	On-line enquiry capabilities should exist to report: all open invoices per vendor, vendor payments activity standard terms, vendor purchase activity: - this period	Should

Section	Functional Description	Priority
	<ul style="list-style-type: none"> - previous periods - previous years payments matched to specific invoices, transactions with different status indicators	
9.2	The system should perform on-line sorted enquiries whereby all vendor information is presented at the user's option: in posting date sequence, in voucher number sequence, in due date sequence, in payment status sequence	Should

4.5 Medical Record Management

Section	Functional Description	Priority
1.0	GENERAL	
1.1	Superior GUI to make data collection easier for the consulting doctors/transcriptionists	Must
1.2	Collated and formatted of information on patients, as required	Must
1.3	Search on patient records by patient names, patient ID, etc.	Must
1.4	Complete clinical data repository	Must
1.5	Capturing basic patient demographic details	Must
1.6	ICD-10 codes for diagnosis and clinical findings	Must
1.7	Rea time ordering of tests and medications	Must

4.6 Human Resource Management

Section	Functional Description	Priority
1.0	GENERAL	
1.1	The system should perform and manage daily attendance entry using biometrics	Must
1.2	Leave accounting and management	Must
1.3	Pay slips management	Should
1.4	Produce payroll reports	Should
1.5		

4.7 Management Information System

Section	Functional Description	Priority
1.0	GENERAL	
1.1	Revenue profile doctor wise	Must
1.2	Revenue profile department wise	Must
1.3	Revenue profile procedure / package wise	Must
1.4	Expense profile doctor wise	Must
1.5	Expense profile department wise	Must
1.6	Expense profile procedure / package wise	Must
1.7	Treatment profile and collection profile	Must
1.8	Exception report on deviation from set of parameters for Purchase, discounts, collections, credits	Should
1.9	Patient registration statistics	Must
1.10	Patient admission statistics by date, ward and consultant	Must
1.11	Patient discharge statistics by date, ward and consultant	Must
1.12	Bed occupancy statistics by date and ward, by doctor	Must
1.13	Outpatient visit statistics by date and clinic	Must
1.14	Contribution Statement	Must

4.8 Financial Management

Section	Functional Description	Priority
1.0	GENERAL	
1.1	All transaction vouchers generated in the system are collated and they are posted on daily basis or online onto the system	Must
1.2	Cash/Credit/Bank Transaction	Must
1.3	Daily Cash Book	Must
1.4	Daily Bank Book	Must
1.5	Account Receivable Statement with Ageing Analysis	Must
1.6	Income & Expense profile department wise / Budget wise	Must
1.7	Supplier Ledger	Must
1.8	General Ledger	Must
1.9	Trial Balance	Must
1.10	P & L	Must
1.11	Balance Sheet	Must
1.12	Expenditure Analysis	Must
1.13	Exception Analysis	Must

5. iHMS System Architecture and Information Exchange

In this section we have proposed a high-level system architecture and minimum ehealth standards necessary for implementing the iHMS. The main purpose of this high-level architecture is to serve as a communication tool that will help decision makers in selecting a solution. The proposed architecture and standards are based on the requirements, literature search and our own experience on designing systems and enterprise architecture. Below we describe both the system and deployment architecture, the deployment architecture and

5.1 iHMS System Architecture

Following the business process analysis and requirements established in the previous section the integrated HMS (iHMS) would be a modular system consisting of several modules. The iHMS modules can be designed according to three categories . core modules, supporting modules and back office modules. These modules can be adapted, deployed and customized according to hospital needs.

5.1.1 Architectural Choices

There are two possible models from which an iHMS can be realized: Best-of-Breed model and Full Integrated Model.

5.1.1.1 Best-of-Breed Model

Best of breed model is a model that selects the *most optimal combination of software resources within Hospital Information System in order to attain an overall optima functionality of both data, functions and workflow integrations.*

This refers to the best combination of resources irrespective of vendors and individual performances.

A hospital might choose one functional component as a product and combine it with a different product for billing, another for LIS, and yet another for

pharmacy and inventory. One aspect of best-of-breed solutions is linking the components of the legacy system (billing software, for example) to the new iHMS system.

One or more integration engine products must be added to this mix to enable integration and sharing of information among the different applications.

This approach has its shortcomings:

- *A break in data linkages.* The best-of-breed scenario involves multiple products built by different vendors in different languages that must communicate reliably with one another. The most common problem is that the transfer of data between programs stops. Typically, the solution is simple but disruptive.
- *No single point of accountability.* Merging software products from different vendors implies many points of accountability. When one part of the system stops working, it can be difficult to determine which program is faulty and who the appropriate person is to call.
- *Weaker integration with third-party services or software.* Products in the best-of-breed model tend to lag behind the fully integrated products in terms of their ability to assimilate with productivity-enhancing services such as online insurance eligibility, lab interfaces, and PDAs for hospital charge capture. Generating complex reports also is a problem because the practice management and clinical data are separate, and data has to be captured from several sources and manually integrated into one report.
- *Problems in upgrading best-of-breed systems.* As the multiple products within a best-of-breed system need upgrading, the upgrading process can introduce incompatibilities among the different versions of each product.

5.1.1.2 Full-Integrated Model

Largely, fully integrated HMS are built from the ground up on a single platform and are designed to perform registration, admission, billing, scheduling, EMRs, laboratory, and electronic prescribing, in a self-contained system. Fully integrated systems tend to be more reliable, because they are developed on a single platform; data flows between software functionalities are usually seamlessly. One developer means a single point of accountability for software issues. Reporting on practice management and clinical data is easily accomplished. Finally, fully integrated products tend to integrate effortlessly with labs, PDAs, and other productivity enhancing services and security. Figure 5.1 depict a fully integrated model in which different functionality and integration models are displayed. It is important to also mention that full-integrated models are not limited to original functionality or services. Components can be added or removed during software development life cycle.

Despite the benefits, full integrated models also has their short comings

1. Often time full-integrated models are vendor specific and proprietary. This limit the flexibility to edit, add or remove components without vendor's authorization.
2. Sustainability depends on the owning vendor or a community of software developed

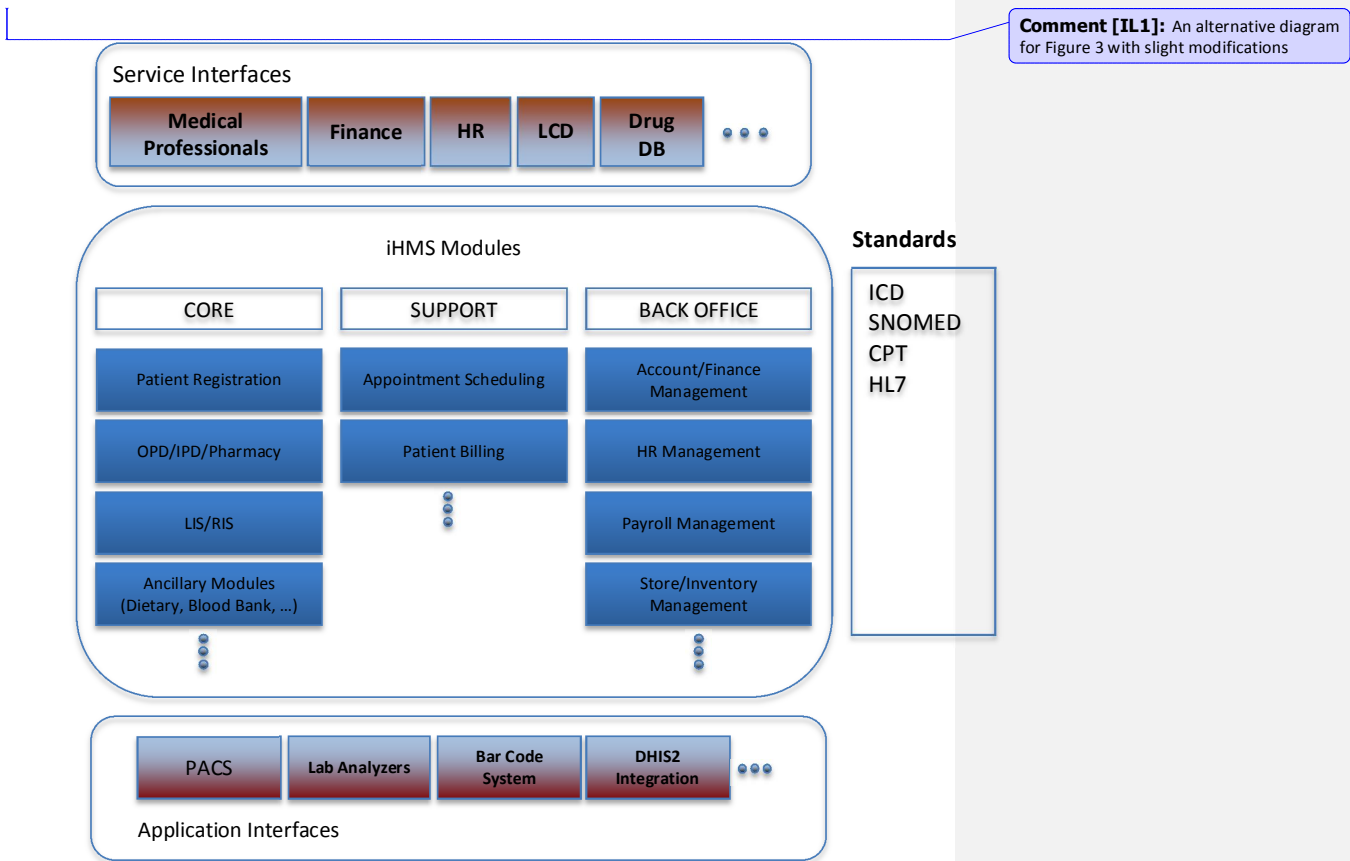

Figure 5.1: Full Integrated iHMS Architecture

5.2 iHMS Deployment Architecture

The term deployment architecture describes the manner in which the system is deployed. This is related to the UML definition of deployment architecture but the focus is more on the strategic implications of a deployment choice and less on the technical decisions i.e. how to allocate work in a multiprocessor computer system. There could be several possible ways for deploying the iHMS, however following our analysis and experience we identified two possible deployment architectures that are widely accepted from which the iHMS can benefit. They are cloud-based centralized and facility-based decentralized architecture model.

5.2.1.1 Facility-based Decentralized system model

The first model is the decentralized where each hospital deploys a full and independent functional system that can synchronize with the central system. In this model the iHMS is hosted in data center located within hospital local area network (LAN). Since one of the goals of the Ministry is to be able to get access to some of the information necessary for health care managers and decision makers, a data warehouse is recommended to capture aggregate data. The red colored part of Figure is a good example of how this deployed can be realized.

With the current infrastructure, this model is more reliable however it is costly.

Benefits of decentralized approach

1. Deployments and maintenance are completely independent and are isolated from one another. Therefore one system breakdown does not mean another system break down.
2. Database resources are locally available therefore increases reliability and speed

3. Decentralized systems are usually one copy but multiple instances deployed across different organization units. In this case, it is easier to build technical capacity and support staff for system maintenance.
4. Core hospital activities does not depend on internet

Shortcomings

1. Deployments is costly, each site requires a complete set of tools and resources.
2. Each upgrade or modification to the application will require a physical visit to the either machine or applications

5.2.1.2 Cloud-based Centralized system model

The second model is the centralized model that may take the cloud-based solution. In this model the iHMS will be hosted in the cloud (could be private or public) and users will access the it through an Internet connection of the hospital network (LAN). In this solution, all hospitals use the same cloud solution and access to the iHMS through their Internet connections. Figure 3.2 present a high-level deployment architecture of the cloud-based iHMS.

This model provides the ability to better control costs, eliminates the responsibility for upgrades, promotes access wherever an internet connection is available, and gives information in real-time. This is a newer technology and one of its advantages is its low adoption cost.

Benefits

1. . This yields maximum control of the system

Shortcomings

1. This deployment usually depends on either an Internet based hosting or cloud based service. Both of these options require Internet connectivity in order to provide services to clients, which in our case, these are hospitals located in different locations.

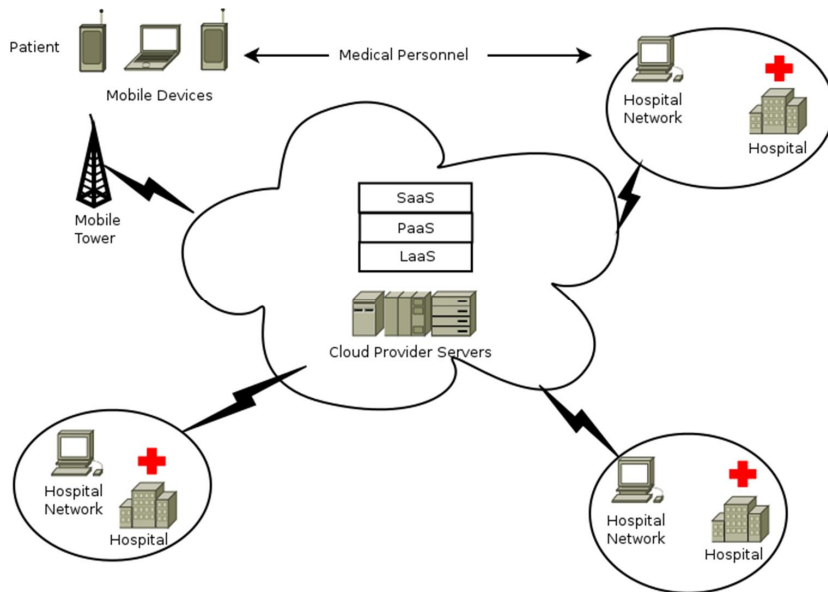

Figure 3.2: Cloud-based Solution for iHMS

Comment [IL2]: Same information above???

5.3 iHMS and the National HIS Architecture

Several information systems exist in the health sector such as electronic logistic information systems (eLMIS), EMR systems that run as independent module/system such as CTC 2 Database, Planning and Reporting System (PlanRep), and District Health Information System (DHIS) 2. In accordance to the national eHealth strategy, it is encouraged that the development of eHealth solutions follows the enterprise architecture (EA) as an approach. The EA approach emphasizes on: leveraging what currently exists in the Tanzanian eHealth landscape; understand what the new components are and where they fit in existing structures; define information structures to fit current needs and to support anticipated ones; and demonstrate how

technology and resource constraints dictate both what is feasible and the path forward.

Following the EA approach as we look forward towards implementing the iHMS it is important to have a holistic view of the national HIS architecture and see how iHMS fit to the whole thing. While there is no developed and agreed national HIS architecture, we have adapted OpenHIE model, after consultation and discussion with MOHSW IT team, to identify and indicate possible information exchanges required between iHMS and other components of the overall National HIS Architecture. This is important, as it will influence the planning and selection of the iHMS solution.

Figure 5.3 depict the National HIS architecture which instantiate the OpenHIE model. It consist of several components that can share and exchange information through the use of the interoperability layer. The openHIE model is based on Service Oriented Architecture (SOA) as a reference architectural style. The loosely coupling of the systems afford scaling and redundancy opportunities, and potentially risk-mitigation options as individual parts may be changed without affecting the overall system behavior. Below we provide a brief description of the components. Red colored components indicates the areas of interest for iHMS implementation.

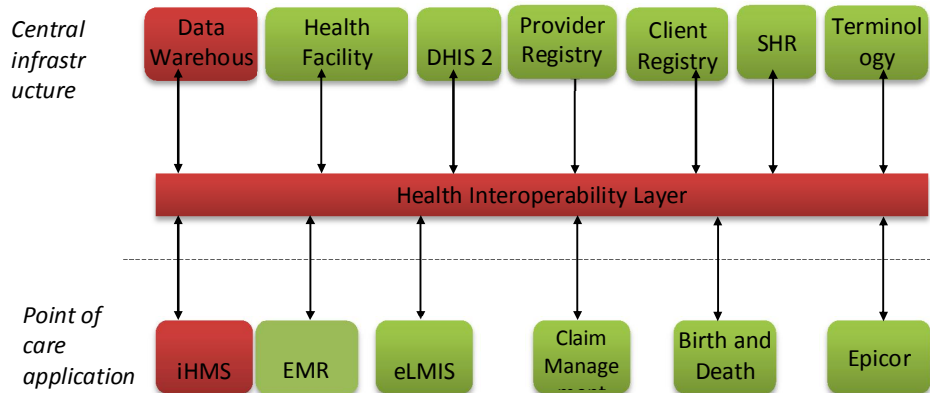

Figure 5.3: Proposed National HIS Architecture

Data Warehouse: The Ministry has adopted DHIS 2 software as a platform for analysis, reporting, and making evidence-based decision for clinical functions. However, the Ministry lacks a solution that would serve as the dashboard for providing analysis, reporting and making data supported decisions regarding health resources (finance, medicine, human resources, etc.). Therefore the data warehouse is intended to integrate information on finance (planning, procurement, contract management, budgeting and expenditure), medical supplies (planning, request, distribution, and utilization) and health professionals to enable systematic approach in managing health sector resources.

Interoperability layer: An interoperability layer is a system that enables easier interoperability between disparate information systems by connecting all of the infrastructure services and client applications together. It receives transactions from client systems, coordinates interaction between components and provides common core functions to simplify the interoperability between systems.

iHMS. The iHMS system will be a full and independent functional system that can synchronize with the central system. The data captured at a point of care is stored on the facility level iHMS. Data is aggregated at central data warehouse to data supported decision making by healthcare managers (i.e. MOHSW, RMOs, DMOs and PMO-LARG) and other stakeholder such as donors, development partners and implementing partners.

Client Registry (Master patient index (MPI)) manages the unique identity of citizens receiving health services with the country.

A **Provider Registry** is the central authority for maintaining the unique identities of health providers within the country.

A **Health Facility Registry** serves as a central authority to uniquely identify all places where health services are administered within the country.

A **Shared Health Record** (SHR) is a repository containing the normalized version of content created within the community, after being validated against each of the previous registries. It is a collection of person-centric records for patients with information in the exchange.

A **Terminology Service** serves as a central authority to uniquely identify the clinical activities that occur within the care delivery process by maintaining a terminology set mapped to international standards such as ICD10, LOINC, SNOMED, and others

Standards

Requirement 3.1.9 (Integration and information exchange), requires the iHMS be able to share and exchange information with various system in the health sector. This is important because of several reasons, increased efficiency through decreasing entry of duplicate data, decreased errors in medical information through the same mechanism, increased availability of health

information promoting better clinical decision making, and improved continuity of patient care.

The integration and information sharing between health systems requires systems be interoperable. The interoperability is achieved through standardization. While there exist well-established international ehealth standards, a country specific ehealth standard is critical to the implementation of an integrated health information system. We therefore recommend the development of the national ehealth standard framework. In this section identifies a minimum set of standards required for implementing iHMS as the core component of the national integrated health information system. The standards have been drawn from international standards.

5.3.1 Contents Standards

The iHMS system is required to have the capability to transmit and receive a defined minimum set of patient data via standardized HL7 messaging.

5.3.2 Data Format Standards

With the exchange of information, data standards have been developed to ensure consistency of both structure and meaning of data between information systems. Standard formats require agreement both on format (syntax) and meaning (semantics). Format is the order and structure of specific data fields, while meaning is expressed through the choice of coding schemes, rules, and other constraints on content. Standard formats require agreement both on format (syntax) and meaning (semantics). For transmission of patient-level data, the most widely implemented messaging standard in use in the public health sector is recommended. The following international protocol is recommended:

5.3.2.1 Health Level 7(HL7)

HL7 is a flexible standard by which various health care systems can communicate with each other; it is typically used for transmission of patient level data. There are no well-established standards for aggregate data or indicator transmission; however there are two that are emerging:

- Quality Reporting Document Architecture (QRDA) is being developed on the HL7 Clinical Document Architecture model.
- Statistical Data and Metadata Exchange (SDMX-HD) is a data exchange format. SDMX-HD has been developed by WHO, based on the ISO SDMX reporting standard, to facilitate exchange of indicator definitions and data in aggregate data systems.

5.3.2 Coding Standards

The iHMS system should be able build up the data for medical records using standard classification systems such as International Classification of Diseases (ICD).

5.3.2.1 ICD and SNOMED CT

International Classification of Diseases (ICD) is a statistical classification system used to assign diagnostic and procedural codes in order to produce coded data for statistical analysis, epidemiology, reimbursement and resource allocation. SNOMED CT is a clinical terminology designed to capture and represent patient data for clinical purposes. Both systems use standardized definitions and form a common medical language used within the electronic health record (EHR) systems. SNOMED CT enables information input into EHR during the course of patient care, while ICD facilitates information retrieval, or output, for secondary data purposes.

6. Assessment of Existing Information Systems in Health Facilities

This chapter presents assessment of existing Information Systems in the health facilities deployed to handle either clinical or administrative or both. The overall objective of this task was to assess whether existing Information System can be adopted to other health facilities or be scaled-up at national level. Section 5.1 covers characteristics of surveyed health facilities. Sections 5.2 and 5.3 present findings and recommendations respectively.

6.1 Characteristics of Surveyed Health Facilities and Assessment Tool

To get reliable data, consultant deployed multiple methods to required data. A total of forty four health facilities in nineteen (19) regions were assessed. Out of these facilities, nineteen (19) are district level facilities, nineteen (19) are regional level facilities, and four (4) are referral or zonal level facilities. Additionally, two (2) are private health facilities. The reader is referred to Appendix B for a complete list of health facilities assessed.

To accomplish this assignment, consultant developed assessment tool and used it consistently in all health facilities. The tool consists of six (6) functional or business areas. These include Patient care management, Laboratory, Order management, Billing, Pharmacy and inventory, and Finance and accounts. Every functional or business area was assessed with at least five (5) questions. Each question tests one function. The tool had 162 functions to be tested against each existing system. See Appendix C for a detailed assessment tool.

6.2 Findings of Existing Information Systems

The data revealed that fifteen (15) out of forty four health facilities had Information System covering various functional/business areas or part of it. This is equivalent to 34% of all health facilities assessed. Furthermore, a total of eight (8) different types Information Systems were identified being used by 15 health facilities. Each of the

assessed system in the health facilities was subjected to the assessment tool of 162 functions, refer to Appendix C. The results indicate that five (5) out of eight (8) scored less than 50% of the total tested functions. Two systems scored above 50% which are AfyaPro and Care 2X with WebERP. Table 6.1 presents hospital functions supported by various identified Information System.

In general, it was learned that these deployed systems are faced with various challenges which hinders its maximum utilisation. These include lack of deployment strategies, lack of system support from vendors or community, fragmented functionalities, interoperability challenges, and lack of known enforced security features. Some information such as cost involved in deploying and maintaining the system were not available for reasons not revealed to the consultant.

Table 6.1: Hospital Supported Functions

System	Number of functions			% of coverage
	Supported	Unsupported	Total (Assessment Tool)	
4PAY	18	144	162	11
eHMS	81	81	162	50
BUMI expert	24	138	162	15
DAISA	17	145	162	11
LabNet	60	102	162	37
AfyaPro	101	61	162	62
Care2X+WebERP	133	29	162	82
eIntelliHealth	23	139	162	14

Parallel to that, the study went further to examine type and platforms of the identified systems with corresponding number of users. This assessment employed a desk review approach and did not use the

assessment tool elaborated in Appendix C. It was observed that half of these systems fall in the category of free and open source software (FOSS) and others are proprietary. The former had 29 users (health facilities) while the later had 25 users. Table 6.2 summarise these findings.

6.3 Conclusion and Recommendations

The observed facts on existing systems in the health facilities indicate that no single system qualify adoption or scaling up. Limited features/functionalities, interoperability, and lack of meaningful long term support are main reasons for this argument.

Thus, consultant recommends that the MoHSW consider other options in acquiring the iHMS. The options may involve establishing a national development team composed of a mix of indigenous and other developers. The advantage of using home-grown developer is to ensure effective maintenance and long term sustainability. Other options may include out sourcing or buying on the shelf software.

Table 6.2: Characteristics of Existing Systems

System	License Type (Proprietary/ FOSS)	Platform	Vendor/Support	Year developed	Health Facilities
4PAY	FOSS	PHP/MySQL	Noel Kaaya - Individual	2010	6
EHMS	Proprietary/FOSS	PHP/MySQL/ORACLE	GPITG	2012	2
BUMI expert	Proprietary				1
Disa*Lab	Proprietary	SQL, .NET	Laboratory System Technologies (Pty) Ltd South Africa	1981	National Labs

LabNet	Proprietary		Napier Healthcare Solutions (T) Ltd		23
AfyaPro	Proprietary/FOSS	C-sharp, .NET	NPK Technologies	2006	20
Care2X+WebERP	FOSS				1
EIntelli Health	Proprietary				2

7.0 Acquisition and Implementation of an iHMS

7.1 Acquiring an iHMS

Before implementing the iHMS in a health facility, the management through the iHMS Steering Committee has to decide how to acquire the software for implementation. There are two possible options to obtain the right software for your hospital as shown in the figure 7.1.

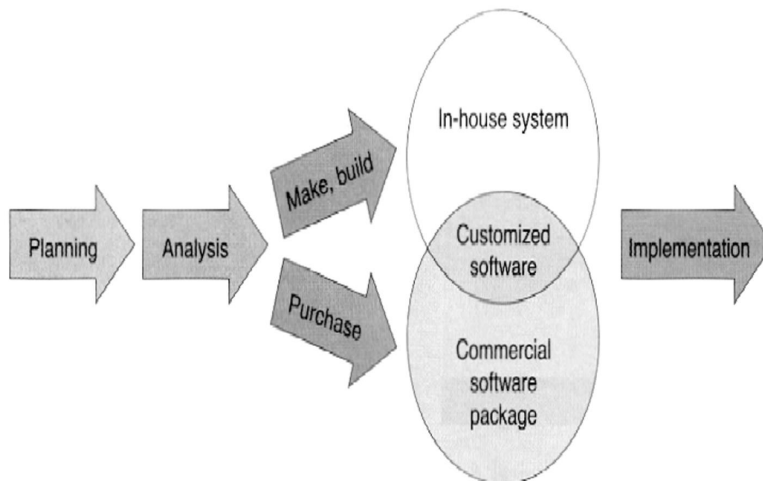

Figure 7.1: Alternatives of acquiring a software (Peter Lo, 2007)

7.2 Recommendations during acquisition

The following are guidance should be adhered to in whichever option of acquiring a hospital software

- Gather requirements from all functional areas which will be use the system.
- Involvement and participation of management, ICT staff, subject matter experts and end-users within the hospital during the requirements analysis, selection and customization and deployment of the software.

- Whenever possible invite experts from other hospital which have used the same or a similar system.

7.3 Make and Build from scratch or customization of an existing software

Another option for acquiring the software at a facility is either in-house or outsourced development of the system or customization of an existing software from a vendor or free and open source system market.

The ministry or individual hospital may consider using public private partnership (PPP) to acquire an iHMS through Build. operate. transfer (BOT) project financing form. Customized software is an alternative which will deliver value to a hospital in providing a software which meets exact requirements as defined during analysis and specifications.

The consultant recommends the ministry to select one software as iHMS among the free and open source systems that have scored high in our evaluation. The selection process should be preceded by detailed evaluation of the software qualities and other technical and financial factors. The selection iHMS can be customized by a selected software development company through a competitive tendering process. The vendor may also agree with hospital or the ministry on payment modalities in which one model will be to recover the costs from revenue surplus revenues generated after the implementation of the system.

7.4 Purchasing an existing software (Commercial-off-the-shelf software)

One possible option to acquiring the software at a facility is to buy existing software from a vendor. This option is further divided into two alternatives.

1. Purchase software as a product in which a hospital purchases a software and host it and managing itself while paying for annual license and maintenance fees. The source code is coded by the vendor.

2. Purchase software as service from a vendor who will be responsible for deployment, implementation and maintenance while a hospital will be paying fees for the service provided by the vendor. The vendor will have sole ownership of the system

There are several factors to consider when buying the software, however one of the main factor is the Total cost of ownership (TCO). TCO is a financial estimate of both the monetary impact and human resource impact of acquiring, deploying, and retiring an information technology system over the life cycle of the product. It is comprised of a number of factors that can be categorised as: Acquisition (one time) expenses and Operational (ongoing) expenses. The overall goal is to select technology that minimizes TCO while meeting minimum functional and operational standards. Other challenges which should be critically analysed in order avoid them from occurring include:

- Dependency on the software vendor which sometimes leads to vendor lock in
- Incompatibilities from future modifications or upgrades of other systems
- Difficulty in integration with other systems
- Security issues

The selection process should include not only software qualities but vendors qualities such as

- Years of experience in the business
- Years of experience in iHMS development and implementation
- Financial capabilities e.g. total sales of the last years
- Total customer base
- The software sales modalities i.e. modular or complete software package
- The operating platforms

- Number of Licenses issued
- Training arrangements and costs
- User support and maintenance mechanisms

Guidelines

When evaluating the total cost of ownership (TCO), the following factors are to be considered:

1. Acquisition Expenses
 - Software licensing
 - Hardware (server, client workstations, mobile devices)
 - Infrastructure (networking hardware and software)
 - Technical support for installation and configuration costs
 - Initial training costs
2. Operational (Ongoing) expenses
 - Software support . Configuration changes and version updates
 - Training costs
 - Migration costs. Should it ever become necessary to move to another vendor or system then the data within the system should be easy to export to a standard open formats e.g. csv

7.5 Implementing the iHMS

7.5.1 Introduction

Selecting a best (right/correct) software is a first good step however its successful adoption depends heavily on a careful selection of system implementation methodology and extensive planning process. The implementation plan should be SMART enough to present clear objectives, realistic scope and attainable milestones. Thus a participatory approach should be employed to ensure and secure buy-in from staff and other stakeholders. The approach should be used to create and maintain right knowledge, and positive attitudes and perception about the software itself

and its implementation processes. Moreover technical competencies in using the computing devices and software should be developed to increase readiness for the implementation and adoption of the system.

Introduction of a new technology results into changes in workflows and business operations thus requires staff to learn new technologies and adapt to the new ways of practice. Thus users need to be prepared to handle complications, pitfalls and some levels of frustrations during pre and post implementation phases (during training, launching and post implementation phases).

Hospital management and implementation teams thus require guidance in order to establish conducive environment for successful deployment, operations and maintenance of iHMS at different levels of health care system.

This section therefore provides guidance on requirements, best practices and procedures to be employed throughout the implementation process.

7.5.2 Implementation Planning

The process of introducing and adopting an iHMS software is complex endeavor as it involves many players in a complex hospital settings and requires new knowledge and skills which many health workers may not readily possess. Furthermore it requires adequate resources in terms of finances, human resources, both hardware and software infrastructure, training of the users and proper management of the changes, maintenance of the software and supporting the hospital business operations.

Moreover introduces new ways of work practices leading into changes in already established workflows thus affecting hospitals stakeholders (consumers, suppliers, service providers, health insurers, other hospitals, researchers) in one way or the other. This create a potential of being frustrating undertaking to hospital staff, loss of productivity, client dissatisfactions and stakeholders discomfort.

An extensive implementation process planning is required. There should be a flexible timelines for each stage of the implementation process. This will also

avail a sufficient time for users to properly digest and get acquainted with the previously introduced iHMS modules. A minimal time frame of 18 months is recommended for successful adoption of a health care information system.

This section therefore presents basic requirements, guidelines and best practices to be employed during the iHMS implementation planning process, operation and maintenance.

The plan will serve as guide throughout the implementation cycle including preparatory, training, launching, post implementation and monitoring and evaluation phases.

1. **Preparatory phase:** Issues to be covered in this phase include requirements and specifications for hardware, network and software procurement, network design and installation, human resource requirements, governance structures, capacity building and training needs, mechanisms for change management and communication with stakeholders. It will also be used prepare outcome, budgetary and estimations of the implementation and operation costs, defining roles and responsibility of each actor.
2. **Training phase:** Selection of facilitators and participants, Preparing training programs and schedules, training materials, venues (training labs/computer rooms) and other resources and logistics, assessment forms
3. **Readiness Assessment Phase:** Before launching the system a readiness shall be conducted covering areas of planning and management, infrastructure, data, operation issues, training and support structures and resources (e.g. staff, funds).
4. **Deployment phase (Go-live):** Stipulating standards and procedures for hardware, network and software installations, configurations, testing, management and maintenance; preparing test plans and carrying out system testing (user acceptance testing, competency testing, and usability testing), review of test results and addressing issues identified. It also involves defining and implementing procedures and timelines for complete shifting from manual system to the new electronic system.

- 5. Transition phase:** Stipulating standards and procedures to be followed during changeover from the existing systems (manual or electronic systems) to the new system; this include procedures for parallel execution of the old and new system and schedules for terminating old one, migration of data including backlog data.
- 6. Post implementation phase:** Stipulating procedures for management and maintenance of the system, user training and support, monitoring and evaluation in order to understand success factors and strategies for sustainability of the system, gathering user experiences and concerns for informing future implementations. Monitoring and evaluation template will be developed to activities, timeliness and responsible persons as well as indicators to be measured.

Requirements for implementation planning process

The requirements for implementation planning include:

1. Each hospital shall form an iHMS steering committee to oversee the iHMS implementation and operations
2. There should be an iHMS implementation team for daily operations of the system implementation and operations
3. Each hospital shall appoint a project manager/leader who will be responsible to daily management and supervision of the implementation activities and report to the steering committee
4. The steering committee should conduct a thorough review of each phase of implementation

Implementation Guidance

The implementation planning should take into account different components necessary for the deployment and operationalization of the iHMS including computing infrastructure and human resource requirements, user trainings and supporting, change management, management and maintenance of the system and security aspects. A sample implementation planning template is

provided as an appendix (Appendix 1) to guide development of hospital specific implementation plan.

The process should include the following:

1. A participatory and consultative method should be employed in developing the system implementation plan by including all relevant stakeholders within the project spectrum.
2. The implementation and management plan should be a comprehensive enough to cover all stages of iHMS implementation including monitoring and evaluation system
3. A phased or modular implementation approach is highly recommended in order to minimize service interruptions and risks and provide a room for assessing issues hindering a successful adoption of the system and devise proper measures for timely addressing the challenges.
4. Post implementation reviews shall be conducted by the steering committee within four week of the system deployment and later on quarterly basis. The review among other output should highlight lesson learnt during but not limited to implementation progress, training reports, end-users reactions, operation cost and efficiency, productivity trends, etc.
5. Involvement and participation of and communication with stakeholders. Project communication plan involves defining communication means, frequency and pathways to be used. Different stakeholders to be involved and or informed about the planned introduction of new iHMS in the hospital include all hospital employees, clients, health insurance service providers, suppliers, and research and academic institutions.

7.5.3 Testing phase

A thorough testing of the software and business environment should be conducted to avoid or minimize major failures of the system during launching and post-implementation. Testing the software in production environment



before launching is essential to ensure issues unidentified during planning and testing are identified and rectified. All bugs should identified and fixed and patches applied before going live.

Requirements for testing

- Put in place both testing and production environments
- Develop test plans for the software, infrastructure . hardware, network and other application packages
- Involve different user groups such as end-users, super users and technical staff
- Conduct unit, module, integration testing, hardware testing, network testing, user testing
- Document test results and timely and appropriately fix problems identified during each test phase
- Users should be give adequate time and resources to test the software system
- Testing be done for all possible cases and all business operation scenarios using involve mock patients, live situations and workflows and other related business data for each specific function or feature of the software
- Pilot the system in small groups be for scaling up to all hospital departments

7.4 Computing Infrastructure Requirements

Deployment and implementation of the iHMS requires adequate and reliable Information and Communication Technology (ICT) infrastructure for hosting the applications and provide interconnections between the computing devices as well as platforms for users to access the system within or outside the hospital. IHMS vendor or developer must define minimum set of requirements for ICT infrastructure and systems to deploy and use the iHMS in a certain hospital depending of its level or size. The requirements will be

prepared in consultations with hospital managers and ICT staff in order to acquire cost-effective and manageable ICT infrastructure and systems. The following are minimum following structure which should be procured, installed and maintained in the process of ensuring the system is deployed and operational in the organization. Refer to table 7.1

- Data center or server to house all servers, networks and other communication devices.
- Computer training room with adequate number of computers to meet training and other related needs of a specific hospital.
- Workstations . these are computers and other computing devices to be used by end-users in various services points in the hospital.
- Network infrastructure including local area network, wide area networks and Internet connectivity including the physical hardware used to interconnect computers and users.
- Power supply system
- Security issues including both physical and logical security

Table 7.1: Computing Infrastructure requirements

	QUANTITY		
	District	Regional	Zonal
Data Center/Server Room			
Servers	2	2	2
Software (OS, DB system, utilities)	2	2	2
Routers/Firewall	1	1	1
Network switches	1	2	2
Data cabinet	1	1	1
Power distribution Units (PDUs)	1	1	1
Cooling system	1	2	2
Network and power cabling accessories	Various	Various	Various
Fire detectors and extinguishers	1	1	1
CCTV system with 3 cameras, DVR	1	1	1
Computer Room			
Desktop computers	10	20	30
Laptop computers	1	1	1
Software (OS, utilities)	11	21	31
Tables	11	21	31
Chairs	11	21	31
Projectors	1	2	2
Projection Screen	1	2	2
Power distribution Units (PDUs)	1	2	2
Network switches	1	1	1
Data cabinets	1	1	1
Cooling system	1	1	2
Network and power cabling accessories	Various	Various	Various

Renovation (e.g. painting, wiring, ceiling, floor)	Various	Various	Various
Network and Internet Connectivity			
LAN Switch 48ports	1	1	5
LAN Switch 24ports	0	3	12
LAN Switch 16 ports	6	10	20
Data cabinets	3	3	5
Power distribution Units (PDUs)	4	3	5
Network and power cabling accessories	Various	Various	Various
Workstations			
Desktop computers	34	35	93
Software (OS, utilities)	34	35	93
Tables	34	35	93
Chairs	34	35	93
Power distribution Units (PDUs)	34	35	93
Printers	18	18	42

7.4.1 Data Centre /Server room

A data center or server is a room used to install ICT equipment for hosting computer systems and associated components, such as telecommunications and storage systems. The room is the nucleus of the ICT infrastructure thus requires proper planning, installation, management and maintenance including stringent security requirements to keep it operational. It must be built in a secure location free from dust, humidity, heat and water. The room must be equipped with environment monitoring instruments such as temperature, humidity and smoke detectors, surveillance cameras as well as strong physical access controls. All access to the room must be logged in a book or automatically registered using from access control system. Each

hospital which is planning to implement the iHMS should identify a suitable room to be used as a server room.

Requirements

In order to implementation iHMS a hospital requires a spacious, user and environmental friendly room for housing ICT infrastructure and systems in the organization.

Guidance for setting up the server room

- Location and Space requirement:
 - Location: identify convenient location for your server room
 - Identify how much space is adequate for your current and future needs
 - A server room floor should be raised higher than other offices floor in order to prevent slip of water to server room
- Cabling and environment
 - A well structured cabling and well labelled for Local area network (LAN) and electric systems should be installed and maintained
 - Use of rack cabinets for housing equipment and network infrastructure
 - Use rack mountable servers for minimum rack space
 - The room must be air conditioned and well-furnished and free from dust, water leaks
 - Servers must be rack mountable and installed in rack cabinets
- Power supply system
 - The room must have reliable power supply
 - Backup power supply solutions may include Uninterrupted power supply (UPS), Inverter with battery bank, generator or solar power system enough to power all servers and network devices

- All servers and network devices must be powered through UPS
- Security system
 - It must have proper physical security access control
 - Network management must be on separate VLAN
 - It must be installed with CCTV system, fire detectors, fire extinguishers and fire suppressing and other monitoring sensors
 - There should be a backup server outside the data center
 - Door access control systems
 - Use of firewalls and Virtual private networks to guarantee security of the systems
- Performance of the computing infrastructure and systems
 - All systems in the data center require maximum Uptime and Availability
 - Fault tolerance and high availability using a RAID
 - High capacity Network disk drives (NAS) and storage area network (SAN)
 - High performance servers, network devices and systems

7.4.2 Networks and Internet Connectivity

Network and Internet connectivity requirements including network active components (devices) e.g. LAN switches and routers, cables and cabling accessories, and power distribution units. The network requirements and network architecture depends heavily the organizational size, structures and specific needs. The network connections within and outside the hospital is recommended to be designed and implemented in different layers including the core, aggregation, and access layers.

Requirements

- Connections between building should be via fiber optics
- Logical segregation in network using VLANs

- Reliable connectivity
- High Speed WAN/Internet capable of supporting real time applications
- Bandwidth management equipment

Guidance

- Local area network (LAN) should have well structured cabling and well labelled considering quality cabling design
 - Easy operations and management
 - A simple, deterministic topology.
 - Access layer flexibility .
 - Capacity and service scalability
 - High availability and fabric stability.
 - Consistency
- Network management must be on separate VLAN
- Since health information systems may exchange large data it is recommended that enough bandwidth is provided to the health facilities.
- Bandwidth monitoring equipment shall be used to control and manage the bandwidth resources.
- It is recommended that bandwidth be allocated based on network applications. Normal internet applications should be given less priority while patient applications should be given highest priority.

7.4.3 Workstations

End users require computers and other computing devices to access and use the system for the provision of hospital functions.

- Location of workstations should consider convenience of users at the point of care and services delivery points in each functional areas.
- Adequate number of computers to be deployed for optimal operationalized of the system
- Installation should be supervised by a senior staff in each section in consultation with ICT staff

7.4.4 Computer training room

Each hospital requires a dedicated computer room to be used for user training, learning and system testing. The requirements and specification for the computer room varies depending on facility size, number of staff, organizational settings and specific needs.

The computer room should be well-equipped and furnished with at least the following:

- Tables and chairs
- Well functional computers (at least 10 computers for district, 20 for regional and 30 for zonal hospitals are recommended). A low cost solutions such as n-computing is recommended.
- Structured LAN and power system cabling
- Ceiling-mounted projector

7.4.5 Physical and logical security of ICT infrastructure

All computing infrastructure and systems should be designed, installed and configured with maximum security consideration in order to ensure both physical and logical security. Door access control system should be used to provide access to server room for only authorized personnel while closed circuit television system (CCTV) shall be installed for real-time surveillance of sensitive building or areas such as data center.

Use of active directory for management of users, computers and other network resources. The directory shall be deployed and configured to define authentication and authorization to provide security including policies and organization of computers, user groupsq management. Each hospital is required to define how to safeguard iHMS including user identification and password access, authenticating, access rights and levels of privileges. Active directory will be used for managing access to computing resources such computers Operating system and other software applications and licenses.

7.5 Human Resource Requirements

To be successful project implementation requires right people at the right time both within and outside the hospital (<http://www.180systems.com/>). The minimum recommended competencies and roles for key players in the system implementation and operational process are required for a success implementation and management of the iHMS. As part of the implementation planning process personnel requirements, their roles and responsibilities should be established. Proper selection of members of the steering committees and implementation teams is one of the prerequisite for a successful project (Lech, 2014).

Due demanding nature and complexity of ICT implementation the establishment and strengthening of an ICT unit in each hospital is highly recommended. Thus following personnel are recommended to man the unit which will be led by Principal or Senior system analyst. However the human requirements analysis will be reviewed when implementation approach has been selected for example iHMS operations may adopt a data clerk centered approach (retrospective data entry) or a clinician centered data entry approach (point of care systems). Both approaches will have different human resource requirements in terms of numbers of staff and their skills. Refer table 7.2

Table 7.2: Recommended estimates for key ICT cadres for each hospital level:

S/N	JOB TITLE	ZONAL	REGIONAL	DISTRICT
1	System Analyst	2	1	1
2	System/Network Administrator	4	1	1
3	ICT Support Technician	4	1	1
4	Data Entry Clerk/Computer Operator	10	4	3

Roles and functions of the ICT unit

Head of ICT unit in the hospital

The responsibilities of head of ICT unit in the hospital include:

- Management of ICT service provision
- Provision of ICT training
- Change Management - Training personnel to deal with changing organizational procedures and information flow resulting from ICT use.
- Co-ordination of hospital-wide ICT support through an ICT Help Desk which assists management and employees to make best use of the hospital ICT environment
- Coordination establishment requirements for and purchase arrangements of hardware and software and technical support,
- Provision of technical support, development and management of the systems which support the business operation of the hospital
- Identification and management of ICT based risks and disaster recovery planning

System Analyst

- Have good knowledge of the hospital business operations
- A system analyst supports the technical development and smooth running of information systems.
- Analyze a business problem or requirement and propose solutions for improving the business operation
- The ability to work in a demanding environment, meet short deadlines and priorities workload.
- Should possess excellent communication skills both written and verbal and presentation skills.
- Adequate experience in ICT deployment and management in the health care is an advantage
- Development of ICT and iHMS training materials and resources

- Assessment of training needs, planning and preparing for the trainings
- Delivering, supporting and assessing training and communicating effectively with learners.
- Develop and maintain system requirements, specifications, installation and configuration procedures, and user documentations.
- Develop and maintain system standard operating procedures

System/Network Administrator

iHMS implementation and management requires a networking professional to monitor and maintain the network in the hospital. A networking expert will ensure that the computing devices and workstations remain connected to each other and seamlessly exchange data while hardware maintenance experts or technicians are required to keep your system up and running at all times.

The roles and responsibilities of System Administrator/Network manager in assisting the implementation and maintenance of ICT infrastructure and systems in the hospital include:

- Installation, management and maintenance of server systems, the database server and application tools.
- Design, installation and maintenance network infrastructure such as switches and routers, and diagnoses problems with these or with the behavior of network-attached computers.
- Performing database administrator (DBA) roles which include to maintain a database system, ensure the integrity of the data and the efficiency and performance of the system.
- Designing and managing security systems and configurations
- Develop and maintain documentation for ICT infrastructure design, installation and configuration procedures.

ICT support technician

ICT support technicians will assist in the implementation and maintenance of ICT infrastructure and systems in the hospital. Their responsibilities include:

- Ensure and maintain Internet connectivity
- Design, Installation and management of network (cabling and network points) and security
- Design, Installation and management of Web and Email services
- Installation and management of Operating systems, Software applications and Virus protection systems
- installation and maintenance of computers and data communications equipment, and software systems
- participating in demonstrating the use of ICT equipment and systems to staff
- Provision of helpdesk/hotline support to all hospital staff on ICT use
- Perform hardware and software troubleshooting
- Keeping records of work undertaken including entry of information into the asset management system

Data Clerk

A data entry clerk role is to enter, update and maintain information on computer systems and in archives. To ensure as information in these systems is only valuable if it is available, accurate, up to date and useable.

Their responsibilities include:

- Prioritize and perform data entry clerical duties in an organized manner.
- Enter the data recorded on the paper forms onto the appropriate database completely, timely and accurately
- Entering data and information into the iHMS database
- Enter and process data relating to patient care and health workers
- finding and checking patient records
- creating new records and updating existing ones on the computer system

- filing records

Skills required for a data clerk include:

- Computer literacy and touch typing proficiency with adequate speed and accuracy
- An ability to work fast and stay focus for lengthy periods (but with nor or limited errors/mistakes)
- An ability to work to deadlines and good attention to detail
- Good understanding of medical records

7.6 Training Requirements

Effective and efficient implementation, management, maintenance and operations of IHMS depends on empowerment and capacity building of key players in the project. Therefore adequate trainings of all end-users, ICT staff and Regional, district and Hospital managers are required for and successful accomplishment of their roles and responsibilities in smooth implementation. The training planning and implementation process will be guided by the following flow chart.

Requirements for and guidance training planning

- To build a cross-functional team, use the key staff as subject matter experts/champions to participate in requirement gathering, analysis and specifications, software selection or development, and end-users trainings and support.
- The subject matter experts will be trained as trainers for end-users training and support
- Determine training needs among prospective iHMS users and stakeholders.
- Identify ICT staff who will participate during the development or selection of the software, user training and other implementation activities.

- Identify key staff from each department, section and unit which will use one or modules of the IHMS system. Appoint at least one subject matter expert/champion from each sections of the hospital in which the software will be deployed and used.
- Adequate estimate and regular monitor end-users learning curves (allow between 6-12 months for the users to get acquainted with the system and processes)
- Staff should be given adequate time and resources learn not only the software but also new business processes.
- Training of trainers method can be used to save time and costs. However close supervision and follow-ups should be provided by the project implementation team to ensure the same information and apprehension is conveyed to end-users during the trainings and support provided by trainers or super users.
- Computer room: Each hospital requires a dedicated computer laboratory to be used for user training, learning and system testing. Avail a computer room (s) for training and hands-on practice
- Personalized or individualized trainings
- Standardized but allow customization according to the needs of a group or department
- Small groups in a units/department or related business processes
- Employ hands-on practice and coaching method
- Training may be short time but scheduled in increments
- The training timing can be either a fulltime or few hours in a day depending on the convenience of a hospital
- Number of people to be trained on computer skills and iHMS operations depends on its number of prospective users for each system module.
- Appropriate schedules and location (during or outside work sessions; inside or outside work stations);

- Reduce or block schedules or hire temporary employees to cover the workload
- Provide allowances for staff trained outside work stations or beyond usual work schedules
- Ensure timely availability of adequate training resources and logistics for each training session including
 - Participants should be invited or informed well in advance (at least 2 weeks)
 - Adequate stationaries
 - Subsistence and transport allowances for facilitators and participants
 - Refreshments
- Refresher trainings should be arranged as the need arises while new employees will be trained or oriented onsite immediately after reporting and commencing the job
- Monitoring and evaluation: each training sessions should be monitored and assessed. Pre and post training assessment are essential in ensuring the training objectives are achieved. The assessment should include knowledge of, skills and attitudes towards and usability of the IHMS software and system in general. The assessment reports to be used to inform subsequent trainings and other implementation activities.

Number of training participants

The number of participant depends on organizational structure and number of employees targeted to be involved in each training category.

- About 40 subject matter experts (TOTs) in each hospital will be involved in training of trainers for iHMS operations and user support. ICT staff from a hospital, regional and district health offices

- About 255 participants are expected to attend basic computer and iHMS operational trainings in a district hospital
- About 500 participants are expected to attend basic computer and iHMS operational trainings in a regional hospital
- About 742 participants are expected to attend basic computer and iHMS operational trainings in a zonal hospital

Types of trainings

The following are recommended areas/types of trainings for each specific group and function:

1. Computer basics training
2. ICT governance
3. Technical training for ICT staff
4. iHMS operational training
5. iHMS data utilization training

Guidance on the trainings

The following are recommended issues to be covered in each training category

1. Computer basics training

- The training will be conducted prior to the implementation of the system
- All prospective users of iHMS will be trained
- Training location depends on the availability of a computer training room at the implementing hospital or nearby institution
- The training will be divided into number of sessions/batches per functional areas such as departments, sections and units depending several factors including number of staff to be trained, capacity of the

computer room, number of functioning computers, availability and schedules of staff

- It will be conducted by ICT staff of the implementation the hospital, or ICT staff from regional and district administration departments
- It will last for about one week for each training session
- The training will cover issues related to understanding and operation of computer hardware and peripherals, operating system and basic software application and utilities such as folder and file management, word processing and spreadsheet.
- The training will be succeeded by onsite coaching
- Refresher training will be conducted as deemed necessary
- New employees will be trained either onsite or will be included during refresher training

2. ICT staff training for IT infrastructure and systems management

- The training will be conducted during the implementation of the system
- All ICT staff who will be managing and supporting the iHMS will be trained
- Training location depends on the availability of required training resources
- It will be conducted by vendors experts and other experts selected by MoHSW in consultation with regional and district steering committees
- It will last for about one week
- The training will cover issues related to understanding and management of IT infrastructure and system including network, servers, hardware and peripherals, operating system and iHMS software application and databases hardware/software installation, support, maintenance and modification, ICT security and privacy.
- Refresher training will be conducted as deemed necessary including new ICT staff
-

3. IT governance trainings for managers

- The training will be conducted prior to the implementation of the system
- Participants of the training include members of steering committees, health management team and hospital management teams
- The training will be organized in phases by the Ministry with consultation with regional and district steering committees depending on the phases of the system deployment
- It will be conducted by vendors' experts and other experts selected by MoHSW in consultation with regional and district steering committees
- It will last for about one week for each training session
- The training will cover issues related to understanding and operation of IT project management cycles, alignment of IT in hospital business operations, managing project scopes, budget and schedules.

4. iHMS data utilization trainings for high-level managers

- The training will be conducted after the system has been operational.
- All high-level managers at all level (the ministry, region, district and hospital) will be trained.
- The training will be organized in phases by the Ministry with consultation with regional and district steering committees depending on the phases of the system deployment
- It will last for about one week for each training session.
- The training will cover issues related to understanding and procedures for retrieval of various data and information captured by the iHMS system and their in planning, management and development of health care system in hospitals in particular.
- iHMS Standard operating procedures, training guides and use manuals will be developed and used during the training.

5. iHMS system operational trainings

iHMS operational training is divided into two parts:-

- Training of trainers
 - Vendor will conduct training on IHMS operations to ICT staff and subject matter experts from each department which will have iHMS module
 - iHMS modules which crosscut different departments will be trained together
 - Each module training will done for one week
- iHMS operational training
 - The training will be conducted prior to the system deployment
 - All prospective users of iHMS will be trained
 - Training location depends on the availability of a computer training room at the implementing hospital or nearby institution
 - The training will be conducted ICT staff in collaborations with the subject matter experts
 - The training will be divided into number of sessions/batches per functional areas such as departments, sections and units depending several factors including number of staff to be trained, capacity of the computer room, number of functioning computers, availability and schedules of staff
 - It will last for about one week for each training session
 - The training will cover issues related to understanding and operation of iHMS their respective modules, accessing and logins, data entry, updates, cleaning, security and privacy and reports generation and linking other modules.
 - The training will be succeeded by onsite coaching
 - Refresher training will be conducted as deemed necessary

- New employees will be trained either onsite or will be included during refresher training

7.7 Managing and Supporting HMS Operations

Managing and supporting the system operations is an essential ingredient in making iHMS adoption successful thus achieving the intended organizational goals. For all users to efficient and effectively use iHMS properly plan should be devised and operationalized which will including managing computing infrastructure, maintenance of the system, user training and support, disaster preparedness and recovery [plan, regular assessment of system usage, modifications and enhancements of the system and IT infrastructure. The following should be including in the plan

- Provision of technical support
- Mechanisms for identifying changes in business functions and workflows
- Identification of bugs or errors in the hospital software and system configurations
- Modification, fixing and updating the hospital software and other application software
- Changes in the supporting application systems e.g. operating systems, database systems, and hardware required to run the hospital software
- Ensuring security of ICT infrastructure and systems and patient and other business data and information

A regular assessment of the systems should be done to ensure that the systems work as intended and potential problems are identified and fixed before they occur.

1. The High-level Managers is an important group of iHMS project planning and execution process and their support need to be assured at the planning stage. The managers will not be involved in the actual

operations of the iHMS but will need to know, from a general outlook, the role of the system within the health setting, the functions performed by the iHMS, and how functions impact patient care within the facility. The managers will use information collected and stored in the iHMS for service delivery and resource management decisions. A variety of high-level managers will be responsible for utilizing the information generated from the iHMS for decision-making. These include Regional Administrative Secretary, Regional Medical Officers, District Executive Directors, District Medical Officers and health secretaries

2. *Hospital directors/In charges/managers/* are the one who use information collected and stored in the iHMS for better planning and management of service delivery and decisions making.
 - a. Must have a strong working knowledge of how to aggregate and use the information gathered and managed in the iHMS for evidence-based decision-making.
3. *ICT staff (e.g. System Analysts, administrators and technicians):* A group of experts who are responsible for various IT related activities such as to
 - a. Prepare user support plan and related documentations
 - b. Manage and maintain the established IT infrastructure and systems, and iHMS database including system configurations
 - c. Provide end-users training and support.
 - d. Identify and rectify IT infrastructure, user and system problems
 - e. Contribute to the improvement of the system
4. *Hospital based users* who are responsible for collecting, entering, and reporting health data using the iHMS
 - a. Registration of new patients and scheduling of visits.
 - b. Using the visits scheduling to identify the patients expected on a particular day and to identify missed appointments.
 - c. Retrieval of the records of patients attending the clinic.

- d. Entry of individual patient data into the iHMS system. This includes demographic and clinical data.
 - e. Coordination of workflow in the clinics.
 - f. Oversight of the data capture and entry to ensure quality.
 - g. Generation of facility reports for transmission through the iHMS reporting system.
5. Data clerk/computer operator: Competency required include ability enter data, conduct data quality checks and cleaning as well as possess adequate data analysis skills for informing decision making process.

Noted: The following roles assumed to be assigned to users using iHMS, in some cases due to unavailability of staff a user may be assigned more than one role and may have overlapping responsibilities.

8 Governance Model and Policy

Successful implementation of the Hospital Management System (HMS) requires a well-defined governance structure to provide improved visibility, coordination, and control of HMIS activities that are occurring across the Hospital. The main goal of governance is to assure all stakeholders that operations will go as expected· that the results achieved will be in line with the decisions made. The governance structure needs to incorporate the assembly of a management team and technical team to combine the knowledge, skills, and stakeholder needs in a way that absorbs and takes advantage of stakeholder contributions on a continuous basis.

The proposed governance structure for the implementation of iHMS requires consultative and participatory approach at all levels of health care system which include the National eHealth steering committee, a regional iHMS steering committee, district iHMS steering committee, Hospital Management Team and Hospital iHMS implementation Team committee. The iHMS governance structure at different levels is shown in figure 8.1.

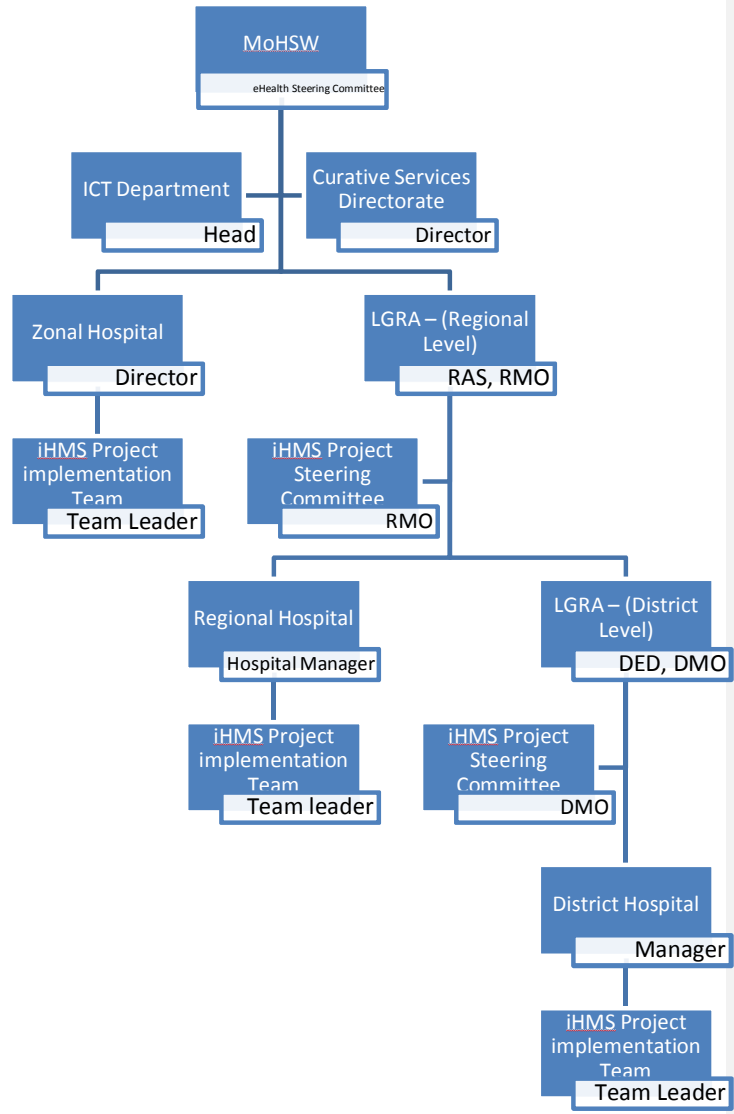

Figure 8.1: The proposed iHMS governance structure at different levels.

Key players in overseeing and implementing iHMS at each level are as shown below

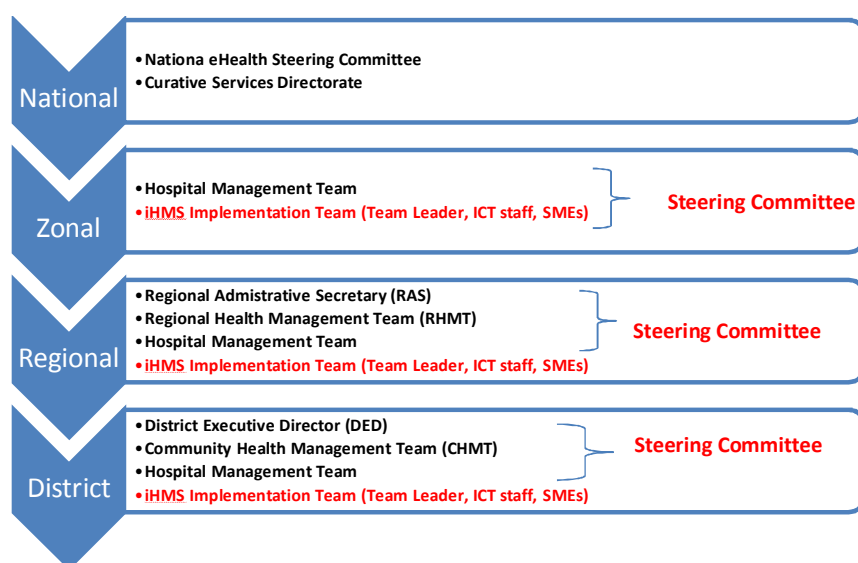

Figure 8. 2: The proposed composition of iHMS implementation teams at different levels.

8.1 iHMS Project Steering Committee

As part iHMS project initiation **each** hospital will form a steering committee which will be responsible for overall management of the project. Depending on the organizational structure and level of the hospital, iHMS project steering committee will be formed by members from different management teams at a particular level (National, Zonal, Regional and District).

The committee is an important component in ensuring the overall success of the iHMS. The committee will provide a system-level perspective to the stakeholders on ICT and iHMS needs, priorities, and initiatives.

The role of the committee is to provide advice to the Hospital and stakeholders on the implementation of the iHMS. Refer figure 8.2

Guidance

- **At the national level:** National eHealth entity will coordinate and guide national rollout of the iHMS and receive and review quarterly progress reports.
- **At the zonal level:** the zonal hospital management team will appoint and oversee the committee.
- **At the regional level:** the committee members will be drawn from the office of Regional secretary and regional health management team under regional Medical Officer through regional hospital management team.
- **At the district level:** the committee members will be drawn from the office of district executive director, district health management team under district medical officer.

The committees responsibilities include:

- Provide leadership and strategic guidance in moving forward with Regional HMIS as aligned with ongoing priority projects in the National eHealth Strategy.
- Set and prioritize iHMS related policies and projects, including regulating and approving iHMS projects from the partners, and assessing and identifying start-up and subsequent iHMS projects.
- Oversee HMS plans, standards, and harmonious execution of all projects.
- Establish criteria for identification and selection of HMS solutions.
- Identify opportunities for collaboration with key Regional, National and International HMS partners.
- Pursue funding opportunities and leverage existing investments to support the Regional iHMS.
- Provide advice to the regional and district administration, hospital and stakeholders on the allocation or reallocation of resources as appropriate to achieve the iHMS.
- Oversee the implementation of the iHMS.

- Champion iHMS initiatives at their respective levels.
- Prioritize business requirements
- Benchmarking: Explore and analyze experiences and best practices from organization with same or very similar business processes which have adopted iHMS
- Define and establish objectives, scope, tasks, budget and schedules
- Approve system selection methodology
- Define project organizational structure and assign right people to the project activities
- Define critical success factors/key requirements
- Prepares and reviews quality assurance system
- Select project manager(s) and project implementation team
- Approve subject matter experts
- Oversee vendor selection process
- Guide system development/acquisition and deployment process
- Oversee user trainings and support
- Monitor implementation and resolve any scope issues.
- Resolve project related conflicts
- Assess project related risks and prepare and implement mitigation strategies
- Regularly Submit iHMS adoption progress reports to the relevant authorities.

Hospital iHMS Project Implementation Team

The following are recommended composition of the project implementation team include

- Team Leader
- Subject Matter experts
- ICT staff

Hospital iHMS implementation team leader:

A hospital which is adopting an iHMS requires a dedicated project manager (also referred as client project manager). This will be a key person to oversee the entire project of developing or implementing and managing the iHMS. He/she should be competent in all modules and features of the iHMS. He or she also needs understands all business operations of a certain type of a hospital and comprehend how the software can be properly aligned to the business processes and workflow. Hospital's top management support to the project manager is paramount towards effective and efficient deployment and adoption of iHMS (Lech, 2014). The management should also provide guidance and support to the steering committees and implementation teams. Depending on the complexity of the organizational settings, breath and complexity of the system the hospital may opt to hire a consultant as a dedicated project manager (Lech, 2014).

Requirements for the team leader

- Must have good project management expertise and experience
- Must have clear understanding of the hospital business operations and organizational structure
- Must have experience in the project implementation methodology
- Good communication skills and interpersonal relations

Some of the responsibilities of the team leader are:

- Lead the project implementation team
- Manage scope, tasks, budget and schedules
- Guide and assist in requirements gathering and business process documentation
- Report project progress to the steering committee
- Liaise with the vendor on the project implementation activities
- Focal person for resolving all issues from employees and the vendors
- Prepare, compile, collate and store project documentations

- Resolve project related conflicts
- Assess project related risks and prepare and implement mitigation strategies

Requirements for Subject Matter Experts (SMEs)

The following are recommended requirements or qualities of subject matter experts

- Subject matter experts or Functional expert(s) for each main functional area (department, section or unit) who have good knowledge of the specific hospital business
- Enthusiastic to learn how to use the system
- Good working knowledge of, skills and attitudes towards iHMS
- Ability to motivate others to adopt the system by articulating specific benefits to be offered by the system
- Capable and willing to train and support his/her colleagues
- Have good command of computer operations
- Good presentation and interpersonal communication skills

Some of the responsibilities of the subject matter experts are:

- Conduct interviews to document business process and requirements
- Review business process documentation
- Review the script to be given to vendors for the detailed demonstration
- Attend portions of detailed demonstration of the system
- Participate in selection and evaluation of the respective system modules
- Play key role in the implementation of the new system (design, setup, testing and training)
- Participate in preparation of system documentations
- Conduct end-users training and subsequently provide user support
- Actively participate in monitoring and evaluation of the system after system deployment especially respective system modules
- Collect and collate new user requirements, system issues and bugs

- Liaise with the team leader on resolving issues related to the implemented system modules

Reporting and Accountability

Each committee will report to their respective and existing administrative structure. The regional steering committee will report to Sector-wide Approach (SWAP) through the chairperson (Regional medical officer) and secretary (head of ICT Regional Hospital). The committee submits monthly reports of progress made to the SWAP. The district steering committee will report to regional steering committee. The hospital implementation team will report to the hospital management team which will then report to the district steering committee.

The committee members are accountable to the broader health system. The committees will have an accountability mechanism in the form of an evaluation that the group will conduct annually to assess the following:

- Outcomes based on an agreed-upon work plan
- Adequacy of the established terms of reference.

Membership

The committees will be draw members of different administrative units and will compose of not more than 10 voting members and will consist of one representative from ICT experts from RAS and DED offices, Regional and District Hospitals, other government institutions, associations, partners and experts executing their health activities within zonal, regional or district hospitals. Additional members will be selected at the discretion of the Regional and district health department administration. The committee is a system-level platform comprising the various sectors of the health services continuum. Members are not participating on behalf of their own individual organizations.

The involvement of agencies and sectors beyond those that constitute the committee membership will occur through processes that are employed to undertake the committees work.

Members will be appointed for a two-year term, with a proportional rotation being established to ensure continuity of the group, and each member will sign the terms of reference (outlining their roles and responsibilities clearly) for their commitment for this term.

The Regional and district Medical Officers are proposed to the position of Chairperson of the Regional and district iHMIS Steering committees respectively. The zonal steering committee will be chaired by the zonal hospital director.

Meeting

Each committee shall meet monthly or at the call of the Chairperson with three business days notice.

Quorum

A simple majority of members shall constitute a quorum. Meetings may be held in person or via electronic connections that allow two-way involvement of all participants.

Decision Making

Decisions will be based on consensus. If consensus is not possible, the Chairperson may call a vote. A simple majority vote of those members in attendance will be needed to resolve or approve any issues requiring a vote.

Composition of members of the iHMS Steering Committees

The following tables show proposed members by role of each committee

Table 8.1: iHMS Steering Committee: Members Zonal Hospitals

S/N	DESIGNATION	ROLE
1	Executive Director	Chairperson
2	ICT Manager	Secretary
3	Director of Clinical	Member
4	Director of Finance	Member
5	Director of Nursing Services	Member
6	Head Pharmacy	Member
7	Hospital Secretary	Member

Table 8.2: IHMIS Steering Committee Members: Regional

S/N	DESIGNATION	DEPARTMENT	ROLE
1	Regional Medical Officer	RAS office	Chairperson
2	Heads of ICT/System Analyst	Regional Hospital	Secretary
3	Heads ICT	RAS office	Member
6	Matrons	Regional Hospitals	Member
8	Medical Officers I/C	Regional Hospitals	Co-Chairperson
9	Hospital Secretaries	Regional Hospitals	Member
10	Chief Accountant	Regional Hospitals	

Table 8.3: iHMIS Steering Committee Members: District

S/N	DESIGNATION	DEPARTMENT	ROLE
1	District Medical Officer	DMO office	Chairperson
2	Heads of ICT/System Analyst	District Hospital	Secretary
3	Heads ICT	DED office	Member
6	Matrons	District Hospitals	Member
7	Accountant	District Hospitals	Member
8	Medical Officers I/C	District Hospitals	Co-Chairperson
9	Hospital Secretaries	District Hospitals	Member

8.2 Change management and adaption

A successful adoption of iHMS partly depends on identification and employment of critical success factors and Management of change and associated risks.

Managing changes during iHMS project implementation is not only a complicated assignment but also requirements top management direction and decision making as it involves changes in organization and scope of the project. This may lead into additional budget and time for the new requirements and changes. On the other hand end-users require project guidance on how to easily and swiftly adopt the system while minimizing potential of failures in the process. Proper change management and good communication mechanisms are essential factors for the effective and efficient adoption of the system.

Introduction of the system may lead to several risks initially including employees to create workarounds, frustrations and resistance due to

potential increase in time and efforts to do their work. These issues may result into decline in productivity thus the hospital management and implementation teams should conduct thorough prior planning and understanding the scenarios, regularly evaluate the situations and devise strategies to avoid or mitigate any risks associated with the project. The table 8.4 indicates possible risk, level of impact and measures to mitigate.

Table 8.4 : iHMIS risks and mitigation strategies

Risk	Impact	Mitigation
Lack of funds and other required resources	High	<ul style="list-style-type: none"> • Develop resource mobilization plans • Solicit funds • Employ cost-effective means
Internal and external Interferences	High	<ul style="list-style-type: none"> • Develop or adapt guidelines and standards • Proper planning process • Ensure adherence to guidelines, standards and plans • Regular review guidelines, standards and plans to incorporate new changes.
Reluctance to change among employees	Moderate	<ul style="list-style-type: none"> • Employ consultative and participatory approach at all stages to raise user awareness and sensitization. • Identify champions and active involve them throughout the project. • Use a phased implementation or modular approach • Identify and resolve conflicts timely
Technological failure	Moderate	<ul style="list-style-type: none"> • Develop and implement disaster preparedness and recovery plan.
Security and privacy threats	Moderate	<ul style="list-style-type: none"> • Develop and implement ICT security policy and guidelines

Critical Success Factors

Critical Success Factors determine the success of ICT implementation; they can be drivers or enablers of which their absence can cause failure and their

presence can cause success. Refer table 8.5. Drivers are the factors that encourage or reinforce the successful implementation of ICT. Some of the key factors include:-

Table 8.5: iHMIS key success factors

S/N	Critical Success Factors	Requirements
1	Management Support and Stakeholder involvement.	<ul style="list-style-type: none"> • Top Management support • Consultative and participatory approach through continuous involvement of all stakeholders.
2	Financial Resources	<ul style="list-style-type: none"> • Recognition of iHMS as a priority area during planning and budget preparation. • Diverse resource mobilization mechanisms. • Employ cost-efficient alternatives.
3	Human Resource Capacity	<ul style="list-style-type: none"> • Continuous capacity building (training and support)
4	Infrastructure	<ul style="list-style-type: none"> • Reliable and secure infrastructure to support ICT Services e.g. use of National ICT Broadband Backbone

Appendices

- 8.7 Appendix A: Implementation Plan**
- 8.8 Appendix B: Visited Health Facilities**
- 8.9 Appendix C: Implementation Budget**
- 8.10 Appendix D: Evaluation of existing HMS Functionalities**
- 8.11 Appendix E: Example Schematic Network Design**

APPENDIX D: EVALUATION OF EXISTING HMS FUNCTIONALITIES

Patient Care Management

	User/Functional Requirements	4PAY	eHMS	BUMI Expert	DAISA	LabNet	AfyaPro	Care 2X+ Web ERP	intelliHealth
	ADMISSIONS / REGISTRATIONS								
1.1	Does the system handle all the admission, transfer and discharge operations for the hospital? Does it should allow for a complete registration for a patient, or a quick registration for rapid registration at the Emergency Department?	<input type="checkbox"/>	<input checked="" type="checkbox"/>	<input type="checkbox"/>	<input type="checkbox"/>	<input type="checkbox"/>	<input checked="" type="checkbox"/>	<input checked="" type="checkbox"/>	<input type="checkbox"/>
1.2	Does the system generate a sequential Medical Record Number (MRN) for each new patient registration?	<input checked="" type="checkbox"/>	<input checked="" type="checkbox"/>	<input type="checkbox"/>	<input type="checkbox"/>	<input checked="" type="checkbox"/> for LAB only	<input checked="" type="checkbox"/>	<input checked="" type="checkbox"/>	<input checked="" type="checkbox"/>
1.3	Does the folio account Number is unique for each visit, and is used for all billing	<input checked="" type="checkbox"/>	<input checked="" type="checkbox"/>	<input type="checkbox"/>	<input type="checkbox"/>	<input checked="" type="checkbox"/> for LAB	<input checked="" type="checkbox"/>	<input checked="" type="checkbox"/>	<input checked="" type="checkbox"/>

	User/Functional Requirements	4PAY	eHMS	BUMI Expert	DAISA	LabNet	AfyaPro	Care 2X+ Web ERP	intelliHealth
	purposes?					only			
1.4	Does the system have the ability to capture billing and insurance payment details to enable bills to be sent to correct payer?	<input checked="" type="checkbox"/>	<input checked="" type="checkbox"/>	<input type="checkbox"/>	<input type="checkbox"/>	<input checked="" type="checkbox"/> for LAB only	<input checked="" type="checkbox"/>	<input checked="" type="checkbox"/>	<input checked="" type="checkbox"/>
1.5	Does the system have the ability to make certain fields mandatory during the data capturing process?	<input checked="" type="checkbox"/>	<input checked="" type="checkbox"/>	<input type="checkbox"/>	<input type="checkbox"/>	<input checked="" type="checkbox"/> for LAB only	<input checked="" type="checkbox"/>	<input checked="" type="checkbox"/>	<input checked="" type="checkbox"/>
1.6	Does the system have ability to allocate Doctors in clinics and number of patient wise?	<input type="checkbox"/>	<input checked="" type="checkbox"/>	<input type="checkbox"/>	<input type="checkbox"/>	<input type="checkbox"/>	<input checked="" type="checkbox"/>	<input checked="" type="checkbox"/>	<input checked="" type="checkbox"/>
1.7	Does the system have ability to scheduling patient appointment?	<input type="checkbox"/>	<input type="checkbox"/>	<input type="checkbox"/>	<input type="checkbox"/>	<input type="checkbox"/>	<input checked="" type="checkbox"/>	<input checked="" type="checkbox"/>	<input checked="" type="checkbox"/>
1.8	Does the system have ability to do confirmation and generation of reservation	<input type="checkbox"/>	<input type="checkbox"/>	<input type="checkbox"/>	<input type="checkbox"/>	<input type="checkbox"/>	<input checked="" type="checkbox"/>	<input checked="" type="checkbox"/>	<input type="checkbox"/>

	User/Functional Requirements	4PAY	eHMS	BUMI Expert	DAISA	LabNet	AfyaPro	Care 2X+ Web ERP	intelliHealth
	slips?								
1.9	Does the system have ability to alert/remind patients appointment via email/mobile/SMS	<input type="checkbox"/>	<input checked="" type="checkbox"/>	<input type="checkbox"/>	<input type="checkbox"/>	<input type="checkbox"/>	<input checked="" type="checkbox"/>	<input checked="" type="checkbox"/>	<input type="checkbox"/>
1.20	Do admissions performed through a registration function (inpatient, outpatient, Emergency)?	<input type="checkbox"/>	<input checked="" type="checkbox"/>	<input type="checkbox"/>	<input type="checkbox"/>	<input checked="" type="checkbox"/> for LAB only	<input checked="" type="checkbox"/>	<input checked="" type="checkbox"/>	<input type="checkbox"/>
1.21	Does the system able to flash alert/prompt to Registration Clerk if patient has any outstanding bills?	<input type="checkbox"/>	<input type="checkbox"/>	<input type="checkbox"/>	<input type="checkbox"/>	<input type="checkbox"/>	<input checked="" type="checkbox"/>	<input checked="" type="checkbox"/>	<input type="checkbox"/>
1.22	Does the system have the ability to capture insurance and billing information at admission/registration time? These details will include whether the patient should be billed or not, Guarantee Letter information,	<input type="checkbox"/>	<input checked="" type="checkbox"/>	<input type="checkbox"/>	<input type="checkbox"/>	<input checked="" type="checkbox"/>	<input checked="" type="checkbox"/>	<input checked="" type="checkbox"/>	<input type="checkbox"/>

	User/Functional Requirements	4PAY	eHMS	BUMI Expert	DAISA	LabNet	AfyaPro	Care 2X+ Web ERP	intelliHealth
	Third Party Payer/ Insurance information etc..								
1.23	Does new born admissions based on mother-baby link, ie admission details to be based on mother's admission record?	<input type="checkbox"/>	<input type="checkbox"/>	<input type="checkbox"/>	<input type="checkbox"/>	<input type="checkbox"/>	<input type="checkbox"/>	<input checked="" type="checkbox"/>	<input type="checkbox"/>
1.24	Does the system have ability to check online, real time bed availability status by Ward / Department hospital wide?	<input type="checkbox"/>	<input checked="" type="checkbox"/>	<input type="checkbox"/>	<input type="checkbox"/>	<input type="checkbox"/>	<input type="checkbox"/>	<input checked="" type="checkbox"/>	<input type="checkbox"/>
1.25	Does the system have ability to chronological sequence each transfer and keeps track of patient's movement history?	<input type="checkbox"/>	<input type="checkbox"/>	<input type="checkbox"/>	<input type="checkbox"/>	<input type="checkbox"/>	<input type="checkbox"/>	<input checked="" type="checkbox"/>	<input checked="" type="checkbox"/>
1.26	Does the system have ability for system to check that all formalities have been completed and to trigger warnings?	<input type="checkbox"/>	<input type="checkbox"/>	<input type="checkbox"/>	<input type="checkbox"/>	<input type="checkbox"/>	<input checked="" type="checkbox"/>	<input checked="" type="checkbox"/>	<input type="checkbox"/>
1.27	Does the system check? if a patient has to	<input type="checkbox"/>	<input checked="" type="checkbox"/>	<input type="checkbox"/>	<input type="checkbox"/>	<input type="checkbox"/>	<input checked="" type="checkbox"/>	<input checked="" type="checkbox"/>	<input checked="" type="checkbox"/>

	User/Functional Requirements	4PAY	eHMS	BUMI Expert	DAISA	LabNet	AfyaPro	Care 2X+ Web ERP	intelliHealth
	be bill (ie a patient without a Guarantee Letter), the system will check that a Discharge Bill has been generated, otherwise the discharge is not to be effected								
1.28	Does system have ability to check bed Occupation Inquiry? Ability to display on-line, the status of each bed in any ward, with details of patient occupying the bed.	<input type="checkbox"/>	<input type="checkbox"/>	<input type="checkbox"/>	<input type="checkbox"/>	<input type="checkbox"/>	<input checked="" type="checkbox"/>	<input checked="" type="checkbox"/>	<input type="checkbox"/>
1.29	Does the system have ability to reports of all inpatients in all wards, sorted by ward, by admission date, by admitting doctor, by patient name, by sex etc.	<input type="checkbox"/>	<input checked="" type="checkbox"/>	<input type="checkbox"/>	<input type="checkbox"/>	<input type="checkbox"/>	<input checked="" type="checkbox"/>	<input checked="" type="checkbox"/>	<input type="checkbox"/>
1.30	Does the system have ability to retrieve statistics such as admissions by admission types, Admissions by medical specialty,	<input type="checkbox"/>	<input checked="" type="checkbox"/>	<input type="checkbox"/>	<input type="checkbox"/>	<input type="checkbox"/>	<input checked="" type="checkbox"/>	<input checked="" type="checkbox"/>	<input type="checkbox"/>

	User/Functional Requirements	4PAY	eHMS	BUMI Expert	DAISA	LabNet	AfyaPro	Care 2X+ Web ERP	intelliHealth
	Transfers by transfer type, Discharges by discharge type?								
1.31	Does system have ability Automatic calculation of bed charge if the bed is occupied for more than a pre-defined number of days?	<input type="checkbox"/>	<input checked="" type="checkbox"/>	<input type="checkbox"/>	<input type="checkbox"/>	<input type="checkbox"/>	<input type="checkbox"/>	<input checked="" type="checkbox"/>	<input type="checkbox"/>

2. Laboratory – Anatomical Pathology, Biochemistry, Microbiology, Hematology, Radiology, Blood bank, CSSD, Laundry etc.

S/N	User/Functional requirement	4PAY	eHM S	BUMI Exper t	DAIS A	LabNet	AfyaPr o	Care2 X+We bERP	intelliHealth
-----	-----------------------------	------	----------	--------------------	-----------	--------	-------------	-----------------------	---------------

S/N	User/Functional requirement	4PAY	eHMS	BUMI Expert	DAISA	LabNet	Afyapro	Care2X+WebERP	intelliHealth
2.0	GENERAL								
2.1	The system should be used in the Laboratory, Radiology, Radiology, Bloodbank, CSSD, Laundry serving the needs of the Inpatients, Outpatients, Emergency Departments, Diagnostic patients and Operating Theaters.	<input type="checkbox"/>	<input checked="" type="checkbox"/>	<input type="checkbox"/>	<input checked="" type="checkbox"/>	<input checked="" type="checkbox"/>	<input type="checkbox"/>	<input type="checkbox"/>	<input type="checkbox"/>
Charging									
2.2	Does the system create a charge in the patient's bill for any procedure that is carried out?	<input checked="" type="checkbox"/>	<input checked="" type="checkbox"/>	<input checked="" type="checkbox"/>			<input type="checkbox"/>	<input type="checkbox"/>	<input checked="" type="checkbox"/>
2.3	Does the system have flexibility to determine at which point the patient will be charged for the procedure? For example, for Test AA, the patient could be charged at the point the test is ordered, while he could be charged only when the procedure has been reported for Test BB, or when the procedure has been completed for Test CC.	<input type="checkbox"/>	<input checked="" type="checkbox"/>	<input type="checkbox"/>	<input checked="" type="checkbox"/>	<input checked="" type="checkbox"/>	<input type="checkbox"/>	<input type="checkbox"/>	<input type="checkbox"/>

S/N	User/Functional requirement	4PAY	eHMS	BUMI Expert	DAISA	LabNet	AfyaPro	Care2X+WebERP	intelliHealth
2.4	Does the system an option for a supervisor to reverse a charge if required?	<input type="checkbox"/>	<input type="checkbox"/>	<input checked="" type="checkbox"/>	<input checked="" type="checkbox"/>	<input checked="" type="checkbox"/>	<input type="checkbox"/>	<input type="checkbox"/>	<input type="checkbox"/>
Reports									
2.5	Inquiries by Patient name or MRN, Accession number, Physician, Source (ward / clinic / department), Test Charges collected department/section/personnel wise laboratory/radilogy wise.	<input checked="" type="checkbox"/>	<input checked="" type="checkbox"/>	<input type="checkbox"/>	<input checked="" type="checkbox"/>	<input checked="" type="checkbox"/>	<input type="checkbox"/>	<input type="checkbox"/>	<input checked="" type="checkbox"/>

3. Order Management.

S/N	User/Functional Requirements	4PAY	eHMS	BUMI Expert	DAISA	LabNet	AfyaPro	Care2X+WebERP	intelliHealth

S/N	User/Functional Requirements	4PAY	eHMS	BUM I Expert	DAIS A	LabNet	AfyaPro	Care2X+ WebERP	intelliHealth
GENERAL									
3.0	The Order Management application addresses the order entry, order review and/or validation, It is envisioned that orders can be placed for any ancillary department by any user in the hospital, depending on the security level assigned to her/him	<input type="checkbox"/>	<input type="checkbox"/>	<input type="checkbox"/>	<input checked="" type="checkbox"/>	<input checked="" type="checkbox"/>	<input type="checkbox"/>	<input type="checkbox"/>	<input type="checkbox"/>
Order Entry									
3.1	Does system allow the order entry process can be decentralized? ie an order can be placed from any Computer within the hospital.	<input type="checkbox"/>	<input checked="" type="checkbox"/>	<input type="checkbox"/>	<input checked="" type="checkbox"/>	<input checked="" type="checkbox"/>	<input checked="" type="checkbox"/>	<input type="checkbox"/>	<input type="checkbox"/>
3.2	Does system able to handle the following order types single order, multi-departmental orders?	<input type="checkbox"/>	<input checked="" type="checkbox"/>	<input type="checkbox"/>	<input checked="" type="checkbox"/>	<input checked="" type="checkbox"/>	<input checked="" type="checkbox"/>	<input type="checkbox"/>	<input type="checkbox"/>

S/N	User/Functional Requirements	4PAY	eHMS	BUM I Expert	DAISA	LabNet	AfyaPro	Care2X+ WebERP	intelliHealth
3.3	Does the system allow users to press any type of order, clinical or non-clinical, from any module?	<input type="checkbox"/>		<input type="checkbox"/>	<input checked="" type="checkbox"/>	<input checked="" type="checkbox"/>	<input type="checkbox"/>	<input type="checkbox"/>	<input type="checkbox"/>
3.4	Does system allow each order type to have its own set of pre-determined data fields?	<input type="checkbox"/>	<input checked="" type="checkbox"/>	<input type="checkbox"/>	<input checked="" type="checkbox"/>	<input checked="" type="checkbox"/>	<input type="checkbox"/>	<input type="checkbox"/>	<input type="checkbox"/>
3.5	Does system have option to identify the urgency of an order?	<input type="checkbox"/>	<input checked="" type="checkbox"/>	<input type="checkbox"/>	<input checked="" type="checkbox"/>	<input checked="" type="checkbox"/>	<input type="checkbox"/>	<input type="checkbox"/>	<input type="checkbox"/>
3.6	Does system have option to cancel or Modify an order if it has not been processed yet?	<input type="checkbox"/>	<input checked="" type="checkbox"/>	<input type="checkbox"/>	<input checked="" type="checkbox"/>	<input checked="" type="checkbox"/>	<input type="checkbox"/>	<input type="checkbox"/>	<input type="checkbox"/>
Order Processing									
3.7	Does the system have flexibility to show the status of any order will be updated automatically, real-time, by the system to enable users to have an online review of the status of any order for any patient?	<input type="checkbox"/>	<input checked="" type="checkbox"/>	<input type="checkbox"/>	<input type="checkbox"/>	<input checked="" type="checkbox"/>	<input checked="" type="checkbox"/>	<input type="checkbox"/>	<input type="checkbox"/>

S/N	User/Functional Requirements	4PAY	eHMS	BUM I Expert	DAISA	LabNet	AfyaPro	Care2X+ WebERP	intelliHealth
	Order Inquiry								
3.8	Do the Users can review the status of any order online from anywhere within the hospital?	<input type="checkbox"/>	<input type="checkbox"/>	<input type="checkbox"/>	<input type="checkbox"/>	<input checked="" type="checkbox"/>	<input checked="" type="checkbox"/>	<input type="checkbox"/>	<input type="checkbox"/>
3.9	Do the Users restricted to viewing information only on those patients in their assigned locations?	<input checked="" type="checkbox"/>	<input checked="" type="checkbox"/>	<input type="checkbox"/>	<input type="checkbox"/>	<input checked="" type="checkbox"/>	<input checked="" type="checkbox"/>	<input type="checkbox"/>	<input checked="" type="checkbox"/>
	Charging								
3.10	Does the system create a charge in the patients bill for any procedure that is carried out?	<input checked="" type="checkbox"/>	<input checked="" type="checkbox"/>	<input checked="" type="checkbox"/>	<input type="checkbox"/>	<input checked="" type="checkbox"/> for LAB only	<input checked="" type="checkbox"/>	<input type="checkbox"/>	<input checked="" type="checkbox"/>
3.11	Does the Operating Theatre (OT) Management module will provide all functions required for charging of the Operating Theatres of the hospitals?	<input checked="" type="checkbox"/>	<input type="checkbox"/>	<input type="checkbox"/>	<input type="checkbox"/>	<input type="checkbox"/>	<input checked="" type="checkbox"/>	<input type="checkbox"/>	<input checked="" type="checkbox"/>
3.12	Does system has exception Reports for the following: Surgeries not yet Charged and Surgeries completed but charging not done?	<input checked="" type="checkbox"/>	<input type="checkbox"/>	<input type="checkbox"/>	<input type="checkbox"/>	<input type="checkbox"/>	<input checked="" type="checkbox"/>	<input type="checkbox"/>	<input checked="" type="checkbox"/>

4. Billing Business Process

S/N	User/Functional Requirements	4PAY	eHMS	BUMI Expert	DAISA	LabNet	AfyaPro	Care2X+WebERP	intelliHealth
GENERAL									
4.1	Does the system provide the hospital with a comprehensive facility to track all charges for a patient from the point of registration to the stage of discharge / completion of a visit?	<input checked="" type="checkbox"/>	<input checked="" type="checkbox"/>	<input checked="" type="checkbox"/>	<input type="checkbox"/>	<input checked="" type="checkbox"/> for LAB only	<input checked="" type="checkbox"/>	<input checked="" type="checkbox"/>	<input checked="" type="checkbox"/>
4.2	Does the system allow the billing process flexible so that it can be done for inpatients at pre-defined periods or at end of the episode, while for outpatients it can be done at each service point (either at the point the order is placed or at the point it is completed), or at the end of the visit?	<input checked="" type="checkbox"/>	<input checked="" type="checkbox"/>	<input checked="" type="checkbox"/>	<input type="checkbox"/>	<input checked="" type="checkbox"/> for LAB only	<input checked="" type="checkbox"/>	<input checked="" type="checkbox"/>	<input checked="" type="checkbox"/>
4.3	Does the system fully integrated system so that billing transactions can be automatically	<input type="checkbox"/>	<input checked="" type="checkbox"/>	<input type="checkbox"/>	<input type="checkbox"/>	<input checked="" type="checkbox"/> for LAB	<input checked="" type="checkbox"/>	<input checked="" type="checkbox"/>	<input type="checkbox"/>

	posted to the patient's account from the laboratory, radiology, operation theatres, pharmacy, wards/clinics etc.?					only			
4.4	Does the system allow Patient Billing to be integrated with Accounts Receivable for managing credit patients?	<input type="checkbox"/>	<input checked="" type="checkbox"/>	<input checked="" type="checkbox"/>	<input type="checkbox"/>	<input checked="" type="checkbox"/> for LAB only	<input checked="" type="checkbox"/>	<input checked="" type="checkbox"/>	<input type="checkbox"/>
4.5	Does the system able to classify patients into various Billing Groups in order to group patients into various paying categories?	<input type="checkbox"/>	<input checked="" type="checkbox"/>	<input checked="" type="checkbox"/>	<input type="checkbox"/>	<input checked="" type="checkbox"/> for LAB only	<input checked="" type="checkbox"/>	<input checked="" type="checkbox"/>	<input type="checkbox"/>
4.6	Does the system able to capture various paying categories including but not limited to non-paying / individuals paying cash / individuals with credit facility / sponsored patients (sponsored by insurance company, employer etc.) with credit facility?	<input type="checkbox"/>	<input checked="" type="checkbox"/>	<input type="checkbox"/>	<input type="checkbox"/>	<input checked="" type="checkbox"/> for LAB only	<input checked="" type="checkbox"/>	<input checked="" type="checkbox"/>	<input type="checkbox"/>
4.7	Does the system Billing classes will be determined and entered into the system at registration time?	<input type="checkbox"/>	<input checked="" type="checkbox"/>	<input checked="" type="checkbox"/>	<input type="checkbox"/>	<input checked="" type="checkbox"/> for LAB only	<input checked="" type="checkbox"/>	<input checked="" type="checkbox"/>	<input checked="" type="checkbox"/>
4.8	Does the system have flexibility to print	<input type="checkbox"/>	<input checked="" type="checkbox"/>	<input type="checkbox"/>	<input type="checkbox"/>	<input checked="" type="checkbox"/> for	<input checked="" type="checkbox"/>	<input checked="" type="checkbox"/>	<input type="checkbox"/>

	inpatient bills periodically for all inpatients or individually at the end of the inpatient episode?					LAB only			
4.9	Does the system have flexibility to print interim/provisional bills for inpatients?	<input type="checkbox"/>	<input checked="" type="checkbox"/>	<input checked="" type="checkbox"/>	<input type="checkbox"/>	<input checked="" type="checkbox"/> for LAB only	<input checked="" type="checkbox"/>	<input checked="" type="checkbox"/>	<input type="checkbox"/>
4.10	Does the system have flexibility to print outpatient bills at each service point, at the point that the service is provided or consolidated at the end of the outpatient visit?	<input type="checkbox"/>	<input checked="" type="checkbox"/>	<input checked="" type="checkbox"/>	<input type="checkbox"/>	<input checked="" type="checkbox"/> for LAB only	<input checked="" type="checkbox"/>	<input checked="" type="checkbox"/>	<input type="checkbox"/>
Cashiering Functions									
4.11	Does the system have provision to identify the Cashier Counter during cashier operations to ensure accountability of all transactions processed? This will also record the cashier identifications such as his/her user id, which is unique within the system.	<input checked="" type="checkbox"/>	<input checked="" type="checkbox"/>	<input checked="" type="checkbox"/>	<input type="checkbox"/>	<input checked="" type="checkbox"/>	<input checked="" type="checkbox"/>	<input checked="" type="checkbox"/>	<input checked="" type="checkbox"/>

4.12	Does the system have facility to process various kinds of receipts, for example, Collection against a bill, Collection against an account receivable for patients with credit facility, Collection of a deposit, Collection of a pre-payment etc..?	<input checked="" type="checkbox"/>	<input checked="" type="checkbox"/>	<input checked="" type="checkbox"/>	<input type="checkbox"/>	<input checked="" type="checkbox"/>	<input checked="" type="checkbox"/>	<input checked="" type="checkbox"/>	<input checked="" type="checkbox"/>
4.13	Does the system have facility to process various kinds of refunds, for example, Refund against a bill Refund of a deposit Refund of postponed/cancelled etc.?	<input checked="" type="checkbox"/>	<input type="checkbox"/>	<input type="checkbox"/>	<input type="checkbox"/>	<input type="checkbox"/>	<input checked="" type="checkbox"/>	<input checked="" type="checkbox"/>	<input checked="" type="checkbox"/>
4.14	Does the system have ability to print receipts / refund documents on pre-printed stationery in on-line mode or batch mode?	<input checked="" type="checkbox"/>	<input type="checkbox"/>	<input type="checkbox"/>	<input type="checkbox"/>	<input type="checkbox"/>	<input checked="" type="checkbox"/>	<input checked="" type="checkbox"/>	<input checked="" type="checkbox"/>
4.15	Does system support various types of receipt printing based on visit type, for example, a different receipt is required for an	<input checked="" type="checkbox"/>	<input checked="" type="checkbox"/>	<input checked="" type="checkbox"/>	<input type="checkbox"/>	<input checked="" type="checkbox"/>	<input checked="" type="checkbox"/>	<input checked="" type="checkbox"/>	<input checked="" type="checkbox"/>

	Emergency visit as compared to an Outpatient visit or Inpatient visit?								
4.16	Does system Receipts have system generated sequential numbers, the format of which will be user-defined?	<input checked="" type="checkbox"/>	<input checked="" type="checkbox"/>	<input checked="" type="checkbox"/>	<input type="checkbox"/>	<input checked="" type="checkbox"/>	<input checked="" type="checkbox"/>	<input checked="" type="checkbox"/>	<input checked="" type="checkbox"/>
	Reports								
4.17	Does system Inquiry on Patient Details?	<input checked="" type="checkbox"/>	<input checked="" type="checkbox"/>	<input checked="" type="checkbox"/>	<input type="checkbox"/>	<input checked="" type="checkbox"/>	<input checked="" type="checkbox"/>	<input checked="" type="checkbox"/>	<input checked="" type="checkbox"/>
4.18	Does system Inquiry on Patient Charge Profile?	<input checked="" type="checkbox"/>	<input checked="" type="checkbox"/>	<input checked="" type="checkbox"/>	<input type="checkbox"/>	<input checked="" type="checkbox"/>	<input checked="" type="checkbox"/>	<input checked="" type="checkbox"/>	<input checked="" type="checkbox"/>
4.19	Does system have Inquiry on account status?	<input checked="" type="checkbox"/>	<input checked="" type="checkbox"/>	<input checked="" type="checkbox"/>	<input type="checkbox"/>	<input checked="" type="checkbox"/>	<input checked="" type="checkbox"/>	<input checked="" type="checkbox"/>	<input checked="" type="checkbox"/>
4.20	Does system have list of Receipts?	<input checked="" type="checkbox"/>	<input checked="" type="checkbox"/>	<input checked="" type="checkbox"/>	<input type="checkbox"/>	<input checked="" type="checkbox"/>	<input checked="" type="checkbox"/>	<input checked="" type="checkbox"/>	<input checked="" type="checkbox"/>
4.21	Does system have List of Third Party Payer Bills, to be printed on a pre-defined schedule?	<input checked="" type="checkbox"/>	<input checked="" type="checkbox"/>	<input checked="" type="checkbox"/>	<input type="checkbox"/>	<input checked="" type="checkbox"/>	<input checked="" type="checkbox"/>	<input checked="" type="checkbox"/>	<input checked="" type="checkbox"/>
4.22	Does system have List of discharges to reconcile with bills?	<input checked="" type="checkbox"/>	<input checked="" type="checkbox"/>	<input checked="" type="checkbox"/>	<input type="checkbox"/>	<input checked="" type="checkbox"/>	<input checked="" type="checkbox"/>	<input checked="" type="checkbox"/>	<input type="checkbox"/>
4.23	Does system have Inpatient bills in detail as well as summary?	<input checked="" type="checkbox"/>	<input checked="" type="checkbox"/>	<input checked="" type="checkbox"/>	<input type="checkbox"/>	<input checked="" type="checkbox"/>	<input checked="" type="checkbox"/>	<input checked="" type="checkbox"/>	<input type="checkbox"/>

4.24	Does system have Inquiry on patient financial details by Patient name and Account number?	<input checked="" type="checkbox"/>	<input type="checkbox"/>	<input checked="" type="checkbox"/>	<input type="checkbox"/>	<input checked="" type="checkbox"/>	<input checked="" type="checkbox"/>	<input checked="" type="checkbox"/>	<input checked="" type="checkbox"/>
4.25	Does system have Inquiry on any transactions recorded In an account?	<input checked="" type="checkbox"/>	<input checked="" type="checkbox"/>	<input checked="" type="checkbox"/>	<input type="checkbox"/>	<input checked="" type="checkbox"/>	<input checked="" type="checkbox"/>	<input checked="" type="checkbox"/>	<input checked="" type="checkbox"/>
4.26	Does system have Query in patients current charges and outstanding status?	<input checked="" type="checkbox"/>	<input checked="" type="checkbox"/>	<input checked="" type="checkbox"/>	<input type="checkbox"/>	<input checked="" type="checkbox"/>	<input checked="" type="checkbox"/>	<input checked="" type="checkbox"/>	<input checked="" type="checkbox"/>
4.27	Does system have Top up reports for patients whose current charges have exceeded the deposit paid?	<input checked="" type="checkbox"/>	<input type="checkbox"/>	<input checked="" type="checkbox"/>	<input type="checkbox"/>	<input checked="" type="checkbox"/>	<input checked="" type="checkbox"/>	<input checked="" type="checkbox"/>	<input checked="" type="checkbox"/>

5. Pharmacy and Inventory Business Process

S/N	User/Functional Requirements	4PAY	eHMS	BUMI Expert	DAISA	LabNet	AfyaPr o	Care2X +WebE RP	intelliHe alth
	STOCK CONTROL								
5.1	may pharmacist set the stock levels required by the hospital to maintain one or more pharmacy outlets within the hospital?	<input type="checkbox"/>	<input checked="" type="checkbox"/>	<input checked="" type="checkbox"/>	<input type="checkbox"/>	<input checked="" type="checkbox"/>	<input checked="" type="checkbox"/>	<input checked="" type="checkbox"/>	<input type="checkbox"/>
5.2	can stocks be replenished by a process or manually triggered by the person responsible?	<input type="checkbox"/>	<input checked="" type="checkbox"/>	<input type="checkbox"/>	<input type="checkbox"/>	<input checked="" type="checkbox"/>	<input checked="" type="checkbox"/>	<input checked="" type="checkbox"/>	<input type="checkbox"/>
5.3	Does system Automatically generate reorder documents for the procurement of new stock?	<input type="checkbox"/>	<input type="checkbox"/>	<input type="checkbox"/>	<input type="checkbox"/>	<input checked="" type="checkbox"/>	<input checked="" type="checkbox"/>	<input checked="" type="checkbox"/>	<input type="checkbox"/>
5.4	will the system facilitate manual entry of requisitions from the various wards/clinics/departments in the hospital?	<input type="checkbox"/>	<input checked="" type="checkbox"/>	<input checked="" type="checkbox"/>	<input type="checkbox"/>	<input checked="" type="checkbox"/>	<input checked="" type="checkbox"/>	<input checked="" type="checkbox"/>	<input type="checkbox"/>
5.5	Does the system support Expiry and non-expiry items? For expiry items stock is maintained at batch level with expiry date	<input type="checkbox"/>	<input type="checkbox"/>	<input checked="" type="checkbox"/>	<input type="checkbox"/>	<input checked="" type="checkbox"/>	<input checked="" type="checkbox"/>	<input checked="" type="checkbox"/>	<input type="checkbox"/>

S/N	User/Functional Requirements	4PAY	eHMS	BUMI Expert	DAISA	LabNet	AfyaPro	Care2X +WebERP	intelliHealth
	for each batch; and any store transaction must identify the batches being processed as part of the transaction.								
5.6	Does the system facilitate to record transfers between stores?	<input type="checkbox"/>	<input checked="" type="checkbox"/>	<input checked="" type="checkbox"/>	<input type="checkbox"/>	<input type="checkbox"/>	<input checked="" type="checkbox"/>	<input checked="" type="checkbox"/>	<input type="checkbox"/>
5.7	Does system allow Stock balance to be updated immediately on confirming a transaction (receipt of stock into inventory, returns to vendors, dispensing to patients) to reflect true stock on hand status at any time?	<input type="checkbox"/>	<input checked="" type="checkbox"/>	<input checked="" type="checkbox"/>	<input type="checkbox"/>	<input checked="" type="checkbox"/>	<input checked="" type="checkbox"/>	<input checked="" type="checkbox"/>	<input type="checkbox"/>
5.8	Does the system Automatic validate and warning on expiry of items?	<input type="checkbox"/>	<input type="checkbox"/>	<input checked="" type="checkbox"/>	<input type="checkbox"/>	<input checked="" type="checkbox"/>	<input checked="" type="checkbox"/>	<input checked="" type="checkbox"/>	<input type="checkbox"/>
5.9	Does the system have provision to remove expired items from active stock to be replaced or destroyed?	<input type="checkbox"/>	<input type="checkbox"/>	<input checked="" type="checkbox"/>	<input type="checkbox"/>		<input checked="" type="checkbox"/>	<input checked="" type="checkbox"/>	<input type="checkbox"/>

S/N	User/Functional Requirements	4PAY	eHMS	BUMI Expert	DAISA	LabNet	AfyaPro	Care2X +WebERP	intelliHealth
5.10	Provision for recording physical stock check figures and generating variance reports and automatic adjustments.	<input type="checkbox"/>	<input checked="" type="checkbox"/>	<input checked="" type="checkbox"/>	<input type="checkbox"/>	<input checked="" type="checkbox"/>	<input checked="" type="checkbox"/>	<input checked="" type="checkbox"/>	<input type="checkbox"/>
5.11	Does system allow mandatory entry of reason in adjustments for audit purposes?	<input type="checkbox"/>	<input checked="" type="checkbox"/>	<input checked="" type="checkbox"/>	<input type="checkbox"/>	<input checked="" type="checkbox"/>	<input checked="" type="checkbox"/>	<input checked="" type="checkbox"/>	<input type="checkbox"/>
5.12	Does the Stock transactions effect on financial accounts need to be reflected in the General Ledger based on the accounting linkages?	<input type="checkbox"/>	<input type="checkbox"/>	<input checked="" type="checkbox"/>	<input type="checkbox"/>		<input checked="" type="checkbox"/>	<input checked="" type="checkbox"/>	<input type="checkbox"/>
5.13	Does system have provisions to close each accounting month after all transactions have been recorded for that month?	<input type="checkbox"/>	<input type="checkbox"/>	<input checked="" type="checkbox"/>	<input type="checkbox"/>		<input checked="" type="checkbox"/>	<input checked="" type="checkbox"/>	<input type="checkbox"/>
5.14	Do Outgoing medicines and prescriptions are automatically deducted from its stock list?	<input type="checkbox"/>	<input checked="" type="checkbox"/>	<input checked="" type="checkbox"/>	<input type="checkbox"/>	<input checked="" type="checkbox"/>	<input checked="" type="checkbox"/>	<input checked="" type="checkbox"/>	<input type="checkbox"/>
5.15	Does the system allow each item-store	<input type="checkbox"/>	<input type="checkbox"/>	<input checked="" type="checkbox"/>	<input type="checkbox"/>	<input checked="" type="checkbox"/>	<input checked="" type="checkbox"/>	<input checked="" type="checkbox"/>	<input type="checkbox"/>

S/N	User/Functional Requirements	4PAY	eHMS	BUMI Expert	DAISA	LabNet	AfyaPro	Care2X +WebERP	intelliHealth
	combination, the minimum/maximum quantities and re-order quantities are maintained depending on the policies and procedures adopted for replenishment of stock at the sub-stores and non-stock stores?								
5.16	If the inventory levels reach reorder points, will the system automatically generate purchase orders for reordering by comparing the stock-on-hand with the reorder level? Does the orders reconciled upon delivery?	<input type="checkbox"/>	<input type="checkbox"/>	<input checked="" type="checkbox"/>	<input type="checkbox"/>	<input checked="" type="checkbox"/>	<input checked="" type="checkbox"/>	<input checked="" type="checkbox"/>	<input type="checkbox"/>
MEDICATION ORDERS									
5.17	Does the system allow medication orders to be entered for inpatients that are identified	<input type="checkbox"/>	<input checked="" type="checkbox"/>	<input type="checkbox"/>	<input type="checkbox"/>	<input type="checkbox"/>	<input checked="" type="checkbox"/>	<input checked="" type="checkbox"/>	<input type="checkbox"/>

S/N	User/Functional Requirements	4PAY	eHMS	BUMI Expert	DAISA	LabNet	AfyaPro	Care2X +WebERP	intelliHealth
	by their financial numbers so that medications can be connected to each term of stay separately?								
5.18	Will the system allow order entry in centralized or decentralized locations throughout the hospital, by various categories of staff such as physicians, nurses, clerks or technicians?	<input type="checkbox"/>	<input checked="" type="checkbox"/>	<input type="checkbox"/>	<input type="checkbox"/>	<input type="checkbox"/>	<input checked="" type="checkbox"/>	<input checked="" type="checkbox"/>	<input type="checkbox"/>
5.19	Pharmacist verification, if required, will it be quickly and efficiently entered or modified for conditional medication orders? Clinical alert warnings may be delayed until the pharmacist verification step or may appear during non-pharmacist order entry. In all cases, clinical warnings, including user actions, must be recorded for action and	<input type="checkbox"/>	<input type="checkbox"/>	<input type="checkbox"/>	<input type="checkbox"/>	<input type="checkbox"/>	<input checked="" type="checkbox"/>	<input checked="" type="checkbox"/>	<input type="checkbox"/>

S/N	User/Functional Requirements	4PAY	eHMS	BUMI Expert	DAISA	LabNet	AfyaPro	Care2X +WebERP	intelliHealth
	review at a later time.								
5.20	Does system have Master Codes . the following Master Codes must be set up within the system?	<input type="checkbox"/>	<input checked="" type="checkbox"/>	<input type="checkbox"/>	<input type="checkbox"/>	<input checked="" type="checkbox"/>	<input checked="" type="checkbox"/>	<input checked="" type="checkbox"/>	<input type="checkbox"/>
5.21	Does system have Drug Forms: Code and description for the various forms in which drugs are Available?	<input type="checkbox"/>		<input type="checkbox"/>	<input type="checkbox"/>	<input type="checkbox"/>	<input checked="" type="checkbox"/>	<input checked="" type="checkbox"/>	<input type="checkbox"/>
5.22	Does system have Route of Administration: Code and description for the different methods in which a drug can be administered, e.g. Intravenous, Oral?	<input type="checkbox"/>	<input checked="" type="checkbox"/>	<input type="checkbox"/>	<input type="checkbox"/>	<input type="checkbox"/>	<input checked="" type="checkbox"/>	<input checked="" type="checkbox"/>	<input type="checkbox"/>
5.23	Does system have Instructions for Administration: Code and description for brief instructions on the method of administering a drug to patients?	<input type="checkbox"/>	<input type="checkbox"/>	<input type="checkbox"/>	<input type="checkbox"/>	<input type="checkbox"/>	<input checked="" type="checkbox"/>	<input checked="" type="checkbox"/>	<input type="checkbox"/>
5.24	Will the system enable users to enter all	<input type="checkbox"/>	<input checked="" type="checkbox"/>	<input type="checkbox"/>	<input type="checkbox"/>	<input checked="" type="checkbox"/>	<input checked="" type="checkbox"/>	<input checked="" type="checkbox"/>	<input type="checkbox"/>

S/N	User/Functional Requirements	4PAY	eHMS	BUMI Expert	DAISA	LabNet	AfyaPr o	Care2X +WebE RP	intelliHe alth
	medications into the system from the same screen? Can Medications be selected by mnemonic, brand name, generic name, therapeutic category, or product codes?								
5.25	Does system have allow Common order entry sets will be defined to further expedite the order entry process by having the most commonly used items pre-selected for activation and the less customary items Available for activation?	<input type="checkbox"/>	<input type="checkbox"/>	<input type="checkbox"/>	<input type="checkbox"/>	<input checked="" type="checkbox"/>	<input checked="" type="checkbox"/>	<input checked="" type="checkbox"/>	<input type="checkbox"/>
5.26	Does system have provision to check if there have been medications orders earlier for the same inpatient, then medications issued to the patient must be checked for inclusion of these drugs and warnings issued where appropriate?	<input type="checkbox"/>	<input checked="" type="checkbox"/>	<input type="checkbox"/>	<input type="checkbox"/>	<input type="checkbox"/>	<input checked="" type="checkbox"/>	<input checked="" type="checkbox"/>	<input type="checkbox"/>

S/N	User/Functional Requirements	4PAY	eHMS	BUMI Expert	DAISA	LabNet	AfyaPro	Care2X +WebERP	intelliHealth
5.27	For controlled drugs, Does the supervisor authorize the issue before the transaction can be processed?	<input type="checkbox"/>	<input type="checkbox"/>	<input type="checkbox"/>	<input type="checkbox"/>	<input type="checkbox"/>	<input checked="" type="checkbox"/>	<input checked="" type="checkbox"/>	<input type="checkbox"/>
5.28	Does system have provision for returns against prescriptions?	<input type="checkbox"/>	<input type="checkbox"/>	<input type="checkbox"/>	<input type="checkbox"/>	<input type="checkbox"/>	<input checked="" type="checkbox"/>	<input checked="" type="checkbox"/>	<input type="checkbox"/>
5.29	Does the system provide support for all medication orders, processing, administration, and dispensing in a paperless environment?	<input type="checkbox"/>	<input checked="" type="checkbox"/>	<input type="checkbox"/>	<input type="checkbox"/>	<input type="checkbox"/>	<input checked="" type="checkbox"/>	<input checked="" type="checkbox"/>	<input type="checkbox"/>
REPORTS									
5.30	Does the system generate Drug formulary query by code, trade name and generic name?	<input type="checkbox"/>		<input type="checkbox"/>	<input type="checkbox"/>	<input type="checkbox"/>	<input checked="" type="checkbox"/>	<input checked="" type="checkbox"/>	<input type="checkbox"/>
5.31	Does the system generate Query on patient's total drug profile (all medications and prescriptions to date).	<input type="checkbox"/>	<input checked="" type="checkbox"/>	<input type="checkbox"/>	<input type="checkbox"/>	<input type="checkbox"/>	<input checked="" type="checkbox"/>	<input checked="" type="checkbox"/>	<input type="checkbox"/>

S/N	User/Functional Requirements	4PAY	eHMS	BUMI Expert	DAISA	LabNet	AfyaPr o	Care2X +WebE RP	intelliHe alth
5.32	Does the system generate list of inpatient medication orders by patient, ward and doctor.	<input type="checkbox"/>		<input type="checkbox"/>	<input type="checkbox"/>	<input type="checkbox"/>	<input checked="" type="checkbox"/>	<input checked="" type="checkbox"/>	<input type="checkbox"/>
5.33	Does the system generate Details listed will include the financial number and MRN of the patient, patient name, prescription number and date, drug code and name, start date for the medication, period, dosage, doctor's identity(Doctor prescription code), quantity of the drug prescribed and whether the order is a one-time or repeating prescription?	<input type="checkbox"/>	<input checked="" type="checkbox"/>	<input type="checkbox"/>	<input type="checkbox"/>	<input checked="" type="checkbox"/>	<input checked="" type="checkbox"/>	<input checked="" type="checkbox"/>	<input type="checkbox"/>
5.34	Does the system generate list of outpatient prescriptions by patient, clinic and doctor?	<input type="checkbox"/>	<input checked="" type="checkbox"/>	<input type="checkbox"/>	<input type="checkbox"/>	<input type="checkbox"/>	<input checked="" type="checkbox"/>	<input checked="" type="checkbox"/>	<input type="checkbox"/>
5.35	Does the system generate list of Repeating Orders for a given drugstore/pharmacy and	<input type="checkbox"/>	<input checked="" type="checkbox"/>	<input type="checkbox"/>	<input type="checkbox"/>	<input checked="" type="checkbox"/>	<input checked="" type="checkbox"/>	<input checked="" type="checkbox"/>	<input type="checkbox"/>

S/N	User/Functional Requirements	4PAY	eHMS	BUMI Expert	DAISA	LabNet	AfyaPr o	Care2X +WebE RP	intelliHe alth
	for a specified range of dates?								
5.36	Does the system generate Controlled drug register?	<input type="checkbox"/>	<input checked="" type="checkbox"/>	<input type="checkbox"/>	<input type="checkbox"/>	<input checked="" type="checkbox"/>	<input checked="" type="checkbox"/>	<input checked="" type="checkbox"/>	<input type="checkbox"/>
5.37	Does the system generate List of discontinued drugs?	<input type="checkbox"/>		<input type="checkbox"/>	<input type="checkbox"/>	<input type="checkbox"/>	<input checked="" type="checkbox"/>	<input checked="" type="checkbox"/>	<input type="checkbox"/>
5.37	Does the system generate Stock status report?	<input type="checkbox"/>	<input checked="" type="checkbox"/>	<input type="checkbox"/>	<input type="checkbox"/>	<input checked="" type="checkbox"/>	<input checked="" type="checkbox"/>	<input checked="" type="checkbox"/>	<input type="checkbox"/>
5.38	Does the system generate Stock ledger?	<input type="checkbox"/>	<input checked="" type="checkbox"/>	<input type="checkbox"/>	<input type="checkbox"/>	<input checked="" type="checkbox"/>	<input checked="" type="checkbox"/>	<input checked="" type="checkbox"/>	<input type="checkbox"/>
5.39	Does the system generate Stock Analysis reports on fast moving items, slow moving items and non-moving items?	<input type="checkbox"/>		<input type="checkbox"/>	<input type="checkbox"/>	<input checked="" type="checkbox"/>	<input checked="" type="checkbox"/>	<input checked="" type="checkbox"/>	<input type="checkbox"/>
5.40	Does the system generate Consumption statement by item and by ward/clinic/department?	<input type="checkbox"/>	<input checked="" type="checkbox"/>	<input type="checkbox"/>	<input type="checkbox"/>	<input checked="" type="checkbox"/>	<input checked="" type="checkbox"/>	<input checked="" type="checkbox"/>	<input type="checkbox"/>
5.41	Does the system generate valuation statements by costing units?	<input type="checkbox"/>		<input type="checkbox"/>	<input type="checkbox"/>	<input checked="" type="checkbox"/>	<input checked="" type="checkbox"/>	<input checked="" type="checkbox"/>	<input type="checkbox"/>

S/N	User/Functional Requirements	4PAY	eHMS	BUMI Expert	DAISA	LabNet	AfyaPr o	Care2X +WebE RP	intelliHe alth
5.42	Does the system Expiration list by period?	<input type="checkbox"/>		<input type="checkbox"/>	<input type="checkbox"/>	<input checked="" type="checkbox"/>	<input checked="" type="checkbox"/>	<input checked="" type="checkbox"/>	<input type="checkbox"/>
5.43	Does the system Items to be re-ordered?	<input type="checkbox"/>	<input checked="" type="checkbox"/>	<input type="checkbox"/>	<input type="checkbox"/>	<input checked="" type="checkbox"/>	<input checked="" type="checkbox"/>	<input checked="" type="checkbox"/>	<input type="checkbox"/>
5.44	Does the system Items above maximum stock levels?	<input type="checkbox"/>		<input type="checkbox"/>	<input type="checkbox"/>	<input checked="" type="checkbox"/>	<input checked="" type="checkbox"/>	<input checked="" type="checkbox"/>	<input type="checkbox"/>
5.45	Does the system Daily transaction details report?	<input type="checkbox"/>	<input checked="" type="checkbox"/>	<input type="checkbox"/>	<input type="checkbox"/>	<input checked="" type="checkbox"/>	<input checked="" type="checkbox"/>	<input checked="" type="checkbox"/>	<input type="checkbox"/>
5.46	Does the system On-line stock status Query by item for all stores in the hospital and by store for all items in that store?	<input type="checkbox"/>	<input checked="" type="checkbox"/>	<input type="checkbox"/>	<input type="checkbox"/>	<input checked="" type="checkbox"/>	<input checked="" type="checkbox"/>	<input checked="" type="checkbox"/>	<input type="checkbox"/>
5.47	Does the system Query on stock transactions for an item?	<input type="checkbox"/>	<input checked="" type="checkbox"/>	<input type="checkbox"/>	<input type="checkbox"/>	<input checked="" type="checkbox"/>	<input checked="" type="checkbox"/>	<input checked="" type="checkbox"/>	<input type="checkbox"/>

6. Finance and Accounts

S/N	User/Functional Requirements	4PAY	eHMS	BUMI Expert	DAISA	LabNet	AfyaPr o	Care2 X+We bERP	intelliH ealth
6.1	Will the system cater for the following information on the vendor record?	<input type="checkbox"/>	<input type="checkbox"/>	<input type="checkbox"/>	<input type="checkbox"/>	<input type="checkbox"/>	<input type="checkbox"/>	<input checked="" type="checkbox"/>	<input type="checkbox"/>
6.2	Does the system produce a listing of vendors with activity for a specified period of time?	<input type="checkbox"/>	<input type="checkbox"/>	<input type="checkbox"/>	<input type="checkbox"/>	<input type="checkbox"/>	<input type="checkbox"/>	<input checked="" type="checkbox"/>	<input type="checkbox"/>
VOUCHER ENTRY					<input type="checkbox"/>				
6.3	Does the system provide: invoice register facilities and certification of invoice values?	<input type="checkbox"/>	<input type="checkbox"/>	<input type="checkbox"/>	<input type="checkbox"/>	<input type="checkbox"/>	<input type="checkbox"/>	<input checked="" type="checkbox"/>	<input type="checkbox"/>
6.4	Does the system have optionally register and certify the invoice at the same time?	<input type="checkbox"/>	<input type="checkbox"/>	<input type="checkbox"/>	<input type="checkbox"/>	<input type="checkbox"/>	<input type="checkbox"/>	<input checked="" type="checkbox"/>	<input type="checkbox"/>
6.5	Does the system record to whom invoices have been sent for either approval, GL coding or adjustment?	<input type="checkbox"/>	<input type="checkbox"/>	<input type="checkbox"/>	<input type="checkbox"/>	<input type="checkbox"/>	<input type="checkbox"/>	<input checked="" type="checkbox"/>	<input type="checkbox"/>
6.6	Does the system allow for the following fields in the transaction record: vendor code, vendor reference invoice	<input type="checkbox"/>	<input type="checkbox"/>	<input type="checkbox"/>	<input type="checkbox"/>	<input type="checkbox"/>	<input type="checkbox"/>	<input checked="" type="checkbox"/>	<input type="checkbox"/>

S/N	User/Functional Requirements	4PAY	eHMS	BUMI Expert	DAISA	LabNet	AfyaPr o	Care2 X+We bERP	intelliH ealth
	number, transaction reference for internal use, invoice type, terms, invoice date, invoice receipt date, posting date, due date, period, gross amount, discount, net amount, optional quantity , optional unit price , transaction currency, currency rates, payment method e.g. cheque, bank details, order number and link to order details e.g.. item code, type, order quantity, GL code, hold information - before updating GL, status code - delivered or not, flag advanced paid for items?								
6.7	Does the system check for duplicate vendor invoice numbers?	<input type="checkbox"/>	<input type="checkbox"/>	<input type="checkbox"/>	<input type="checkbox"/>	<input type="checkbox"/>	<input type="checkbox"/>	<input checked="" type="checkbox"/>	<input type="checkbox"/>
6.8	Is there no limit to the number of lines per invoice?	<input type="checkbox"/>	<input type="checkbox"/>	<input type="checkbox"/>	<input type="checkbox"/>	<input type="checkbox"/>	<input type="checkbox"/>	<input checked="" type="checkbox"/>	<input type="checkbox"/>

S/N	User/Functional Requirements	4PAY	eHMS	BUMI Expert	DAISA	LabNet	AfyaPr o	Care2 X+We bERP	intelliH ealth
6.9	Does the system allow General ledger code distributions should be entered on: purchase orders, vendor record, individual lines on an invoice?	<input type="checkbox"/>	<input type="checkbox"/>	<input type="checkbox"/>	<input type="checkbox"/>	<input type="checkbox"/>	<input type="checkbox"/>	<input checked="" type="checkbox"/>	<input type="checkbox"/>
6.10	GL distribution codes should be validated online in the AP and invalid transactions rejected.	<input type="checkbox"/>	<input type="checkbox"/>	<input type="checkbox"/>	<input type="checkbox"/>	<input type="checkbox"/>	<input type="checkbox"/>	<input checked="" type="checkbox"/>	<input type="checkbox"/>
6.11	Does the system check that, the total recorded against the distribution lines equals the total invoice sum?	<input type="checkbox"/>	<input type="checkbox"/>	<input type="checkbox"/>	<input type="checkbox"/>	<input type="checkbox"/>	<input type="checkbox"/>	<input checked="" type="checkbox"/>	<input type="checkbox"/>
6.12	Does the system able to handle discounts as either a percentage or an amount?	<input type="checkbox"/>	<input type="checkbox"/>	<input type="checkbox"/>	<input type="checkbox"/>	<input type="checkbox"/>	<input type="checkbox"/>	<input checked="" type="checkbox"/>	<input type="checkbox"/>
6.13	Will the system automatically post a discount to the correct general ledger account for discounts?	<input type="checkbox"/>	<input type="checkbox"/>	<input type="checkbox"/>	<input type="checkbox"/>	<input type="checkbox"/>	<input type="checkbox"/>	<input checked="" type="checkbox"/>	<input type="checkbox"/>
6.14	Should the system be possible for a group of	<input type="checkbox"/>	<input type="checkbox"/>	<input type="checkbox"/>	<input type="checkbox"/>	<input type="checkbox"/>	<input type="checkbox"/>	<input checked="" type="checkbox"/>	<input type="checkbox"/>

S/N	User/Functional Requirements	4PAY	eHMS	BUMI Expert	DAISA	LabNet	AfyaPr o	Care2 X+We bERP	intelliH ealth
	invoices to be authorized for payment together?								
6.15	Does the system have provisional for matching available whole invoice and line by line?	<input type="checkbox"/>	<input type="checkbox"/>	<input type="checkbox"/>	<input type="checkbox"/>	<input type="checkbox"/>	<input type="checkbox"/>	<input checked="" type="checkbox"/>	<input type="checkbox"/>
6.16	Is it possible to process and authorize a goods received note (GRN/SPRN)?	<input type="checkbox"/>	<input type="checkbox"/>	<input type="checkbox"/>	<input type="checkbox"/>	<input type="checkbox"/>	<input type="checkbox"/>	<input checked="" type="checkbox"/>	<input type="checkbox"/>
6.17	Can credit note be matched with parts of one invoice?	<input type="checkbox"/>	<input type="checkbox"/>	<input type="checkbox"/>	<input type="checkbox"/>	<input type="checkbox"/>	<input type="checkbox"/>	<input checked="" type="checkbox"/>	<input type="checkbox"/>
6.18	Does the amount transactions entered on-line can be posted at the end of the day or period?	<input type="checkbox"/>	<input type="checkbox"/>	<input type="checkbox"/>	<input type="checkbox"/>	<input type="checkbox"/>	<input type="checkbox"/>	<input checked="" type="checkbox"/>	<input type="checkbox"/>
6.19	Does the system Posting update the accounts payable, general ledger?	<input type="checkbox"/>	<input type="checkbox"/>	<input type="checkbox"/>	<input type="checkbox"/>	<input type="checkbox"/>	<input type="checkbox"/>	<input checked="" type="checkbox"/>	<input type="checkbox"/>
	PAYMENTS								
6.20	Is it possible to process manual cheques	<input type="checkbox"/>	<input type="checkbox"/>	<input type="checkbox"/>	<input type="checkbox"/>	<input type="checkbox"/>	<input checked="" type="checkbox"/>	<input checked="" type="checkbox"/>	<input type="checkbox"/>

S/N	User/Functional Requirements	4PAY	eHMS	BUMI Expert	DAISA	LabNet	AfyaPr o	Care2 X+We bERP	intelliH ealth
	and they should appear on the cheque register?								
6.21	Is it possible to pay more than one cheque for a vendor?	<input type="checkbox"/>	<input type="checkbox"/>	<input type="checkbox"/>	<input type="checkbox"/>	<input type="checkbox"/>	<input checked="" type="checkbox"/>	<input checked="" type="checkbox"/>	<input type="checkbox"/>
6.22	Is it possible to stop payment of a specific invoice temporarily?	<input type="checkbox"/>	<input type="checkbox"/>	<input type="checkbox"/>	<input type="checkbox"/>	<input type="checkbox"/>	<input checked="" type="checkbox"/>	<input checked="" type="checkbox"/>	<input type="checkbox"/>
6.23	Is it possible to make a payment during the same processing cycle that the invoice was entered?	<input type="checkbox"/>	<input type="checkbox"/>	<input type="checkbox"/>	<input type="checkbox"/>	<input type="checkbox"/>	<input checked="" type="checkbox"/>	<input checked="" type="checkbox"/>	<input type="checkbox"/>
6.24	Is it possible to pay invoices as specified without regard to the payment scheduled date?	<input type="checkbox"/>	<input type="checkbox"/>	<input type="checkbox"/>	<input type="checkbox"/>	<input type="checkbox"/>	<input checked="" type="checkbox"/>	<input checked="" type="checkbox"/>	<input type="checkbox"/>
6.25	Does the system allow for part payments to be made?	<input type="checkbox"/>	<input type="checkbox"/>	<input type="checkbox"/>	<input type="checkbox"/>	<input type="checkbox"/>	<input checked="" type="checkbox"/>	<input checked="" type="checkbox"/>	<input type="checkbox"/>
6.26	Is it possible for individual items to be paid on the next payment date to be listed in	<input type="checkbox"/>	<input type="checkbox"/>	<input type="checkbox"/>	<input type="checkbox"/>	<input type="checkbox"/>	<input checked="" type="checkbox"/>	<input checked="" type="checkbox"/>	<input type="checkbox"/>

S/N	User/Functional Requirements	4PAY	eHMS	BUMI Expert	DAISA	LabNet	AfyaPr o	Care2 X+We bERP	intelliH ealth
	advance of the cheque processing cycle?								
6.27	Does the system detect Duplicate payments will be identified?	<input type="checkbox"/>	<input type="checkbox"/>	<input type="checkbox"/>	<input type="checkbox"/>	<input type="checkbox"/>	<input checked="" type="checkbox"/>	<input checked="" type="checkbox"/>	<input type="checkbox"/>
6.28	Does system have provision for Individual general ledger codes to be specified for each bank account?	<input type="checkbox"/>	<input type="checkbox"/>	<input type="checkbox"/>	<input type="checkbox"/>	<input type="checkbox"/>	<input checked="" type="checkbox"/>	<input checked="" type="checkbox"/>	<input type="checkbox"/>
6.29	Does system have provision to handles advance payments?	<input type="checkbox"/>	<input type="checkbox"/>	<input type="checkbox"/>	<input type="checkbox"/>	<input type="checkbox"/>	<input checked="" type="checkbox"/>	<input checked="" type="checkbox"/>	<input type="checkbox"/>
6.30	Does system have provision to interface with the general ledger will allow the cheque number reference to be passed into the general ledger to assist with bank reconciliation's?	<input type="checkbox"/>	<input type="checkbox"/>	<input type="checkbox"/>	<input type="checkbox"/>	<input type="checkbox"/>	<input type="checkbox"/>	<input checked="" type="checkbox"/>	<input type="checkbox"/>
6.31	If a posted payment is voided, Does system have provision the GL posting will automatically be reversed?	<input type="checkbox"/>	<input type="checkbox"/>	<input type="checkbox"/>	<input type="checkbox"/>	<input type="checkbox"/>	<input type="checkbox"/>	<input checked="" type="checkbox"/>	<input type="checkbox"/>

S/N	User/Functional Requirements	4PAY	eHMS	BUMI Expert	DAISA	LabNet	AfyaPr o	Care2 X+We bERP	intelliH ealth
PURCHASE ORDER PROCESSING									
6.32	Does the system facilitate matching, of purchase orders, receiving reports and vendor invoices?	<input type="checkbox"/>	<input type="checkbox"/>	<input type="checkbox"/>	<input type="checkbox"/>	<input type="checkbox"/>	<input checked="" type="checkbox"/>	<input checked="" type="checkbox"/>	<input type="checkbox"/>
6.33	Matching will be available for both: the whole invoice and manual matching.	<input type="checkbox"/>	<input type="checkbox"/>	<input type="checkbox"/>	<input type="checkbox"/>	<input type="checkbox"/>	<input checked="" type="checkbox"/>	<input checked="" type="checkbox"/>	<input type="checkbox"/>
6.34	Does the system produce exception reports of unmatched invoices?	<input type="checkbox"/>	<input type="checkbox"/>	<input type="checkbox"/>	<input type="checkbox"/>	<input type="checkbox"/>	<input checked="" type="checkbox"/>	<input checked="" type="checkbox"/>	<input type="checkbox"/>
INTERFACES									
6.35	Does the system have the option to post to the general ledger: at the detail level and summary level by voucher	<input type="checkbox"/>	<input type="checkbox"/>	<input type="checkbox"/>	<input type="checkbox"/>	<input type="checkbox"/>	<input type="checkbox"/>	<input checked="" type="checkbox"/>	<input type="checkbox"/>
6.36	The general ledger will be posted at the same time as the accounts payable subsidiary ledger is posted?	<input type="checkbox"/>	<input type="checkbox"/>	<input type="checkbox"/>	<input type="checkbox"/>	<input type="checkbox"/>	<input type="checkbox"/>	<input checked="" type="checkbox"/>	<input type="checkbox"/>

S/N	User/Functional Requirements	4PAY	eHMS	BUMI Expert	DAISA	LabNet	AfyaPr o	Care2 X+We bERP	intelliH ealth
6.37	Does the system support interfaces to other systems including: Purchasing, receiving, general ledger, stock control?	<input type="checkbox"/>	<input type="checkbox"/>	<input type="checkbox"/>	<input type="checkbox"/>	<input type="checkbox"/>	<input type="checkbox"/>	<input checked="" type="checkbox"/>	<input type="checkbox"/>
VENDOR PURCHASE ANALYSIS (REPORTS)									
6.38	Does system generate a report summarizing purchase and payment history by vendor?	<input type="checkbox"/>	<input type="checkbox"/>	<input type="checkbox"/>	<input type="checkbox"/>	<input type="checkbox"/>	<input type="checkbox"/>	<input checked="" type="checkbox"/>	<input type="checkbox"/>
6.39	Does system generate report listing open items and paid items?	<input type="checkbox"/>	<input type="checkbox"/>	<input type="checkbox"/>	<input type="checkbox"/>	<input type="checkbox"/>	<input type="checkbox"/>	<input checked="" type="checkbox"/>	<input type="checkbox"/>
6.40	Does system generate print vendor statements?	<input type="checkbox"/>	<input type="checkbox"/>	<input type="checkbox"/>	<input type="checkbox"/>	<input type="checkbox"/>	<input type="checkbox"/>	<input checked="" type="checkbox"/>	<input type="checkbox"/>
6.41	Does system generate produce a vendor ledger listing: by vendor number, , alphabetically etc..?	<input type="checkbox"/>	<input type="checkbox"/>	<input type="checkbox"/>	<input type="checkbox"/>	<input type="checkbox"/>	<input type="checkbox"/>	<input checked="" type="checkbox"/>	<input type="checkbox"/>
6.42	Does system able to produce an accounts	<input type="checkbox"/>	<input type="checkbox"/>	<input type="checkbox"/>	<input type="checkbox"/>	<input type="checkbox"/>	<input checked="" type="checkbox"/>	<input checked="" type="checkbox"/>	<input type="checkbox"/>

S/N	User/Functional Requirements	4PAY	eHMS	BUMI Expert	DAISA	LabNet	AfyaPro	Care2X+WebERP	intelliHealth
	payable invoice/voucher register?								
6.43	Does system generate an aged outstanding balance report by vendor in both detail and summary?	<input type="checkbox"/>	<input type="checkbox"/>	<input type="checkbox"/>	<input type="checkbox"/>	<input type="checkbox"/>	<input checked="" type="checkbox"/>	<input checked="" type="checkbox"/>	<input type="checkbox"/>
6.44	Does system generate Aging wise analysis report (e.g. 30,60, 90,120 days) will be user-specified?	<input type="checkbox"/>	<input type="checkbox"/>	<input type="checkbox"/>	<input type="checkbox"/>	<input type="checkbox"/>	<input type="checkbox"/>	<input checked="" type="checkbox"/>	<input type="checkbox"/>
6.45	Does system generate On-line enquiry capabilities will exist to report: all open invoices per vendor, vendor payments activity standard terms, vendor purchase activity: - this period - previous periods - previous years payments matched to specific invoices,	<input type="checkbox"/>	<input type="checkbox"/>	<input type="checkbox"/>	<input type="checkbox"/>	<input type="checkbox"/>	<input checked="" type="checkbox"/>	<input checked="" type="checkbox"/>	<input type="checkbox"/>

S/N	User/Functional Requirements	4PAY	eHMS	BUMI Expert	DAISA	LabNet	AfyaPr o	Care2 X+We bERP	intelliH ealth
	transactions with different status indicators?								
6.46	Does system perform on-line sorted enquiries where by all vendor information is presented at the user's option: in posting date sequence, in voucher number sequence, in due date sequence, in payment status sequence?	<input type="checkbox"/>	<input type="checkbox"/>	<input type="checkbox"/>	<input type="checkbox"/>	<input type="checkbox"/>	<input checked="" type="checkbox"/>	<input checked="" type="checkbox"/>	<input type="checkbox"/>

7. Management Reports

S/N	User/Functional Requirements	4PAY	eHMS	BUMI Expert	DAISA	LabNet	AfyaPro	Care2X+WebERP	intelliHealth
7.0	GENERAL								
7.1	Does system generate Revenue profile doctor wise?	<input checked="" type="checkbox"/>	<input checked="" type="checkbox"/>	<input type="checkbox"/>	<input type="checkbox"/>	<input type="checkbox"/>	<input checked="" type="checkbox"/>	<input checked="" type="checkbox"/>	<input checked="" type="checkbox"/>
7.2	Does system generate Revenue profile department wise?	<input checked="" type="checkbox"/>	<input checked="" type="checkbox"/>	<input type="checkbox"/>	<input type="checkbox"/>	<input type="checkbox"/>	<input checked="" type="checkbox"/>	<input checked="" type="checkbox"/>	<input checked="" type="checkbox"/>
7.3	Does system generate Revenue profile procedure / package wise?	<input checked="" type="checkbox"/>	<input checked="" type="checkbox"/>	<input type="checkbox"/>	<input type="checkbox"/>	<input type="checkbox"/>	<input checked="" type="checkbox"/>	<input checked="" type="checkbox"/>	<input checked="" type="checkbox"/>
7.4	Does system generate Expense profile doctor wise?	<input checked="" type="checkbox"/>	<input checked="" type="checkbox"/>	<input type="checkbox"/>	<input type="checkbox"/>	<input type="checkbox"/>	<input checked="" type="checkbox"/>	<input checked="" type="checkbox"/>	<input checked="" type="checkbox"/>
7.5	Does system generate Expense profile department wise?	<input checked="" type="checkbox"/>	<input checked="" type="checkbox"/>	<input type="checkbox"/>	<input type="checkbox"/>	<input type="checkbox"/>	<input checked="" type="checkbox"/>	<input checked="" type="checkbox"/>	<input checked="" type="checkbox"/>
7.6	Does system generate Expense profile procedure / package wise?	<input type="checkbox"/>	<input checked="" type="checkbox"/>	<input type="checkbox"/>	<input type="checkbox"/>	<input type="checkbox"/>	<input checked="" type="checkbox"/>	<input checked="" type="checkbox"/>	<input type="checkbox"/>
7.7	Does system generate Treatment profile and collection profile ?	<input checked="" type="checkbox"/>	<input checked="" type="checkbox"/>	<input type="checkbox"/>	<input type="checkbox"/>	<input type="checkbox"/>	<input checked="" type="checkbox"/>	<input checked="" type="checkbox"/>	<input checked="" type="checkbox"/>
7.8	Does system generate Exception report on	<input type="checkbox"/>	<input type="checkbox"/>	<input type="checkbox"/>	<input type="checkbox"/>	<input type="checkbox"/>	<input type="checkbox"/>	<input checked="" type="checkbox"/>	<input type="checkbox"/>

S/N	User/Functional Requirements	4PAY	eHMS	BUMI Expert	DAISA	LabNet	AfyaPro	Care2X+WebERP	intelliHealth
	deviation from set of parameters for Purchase, discounts, collections, credits?								
7.9	Does system generate Patient registration statistics?	<input checked="" type="checkbox"/>	<input checked="" type="checkbox"/>	<input type="checkbox"/>		<input checked="" type="checkbox"/>	<input checked="" type="checkbox"/>	<input checked="" type="checkbox"/>	<input checked="" type="checkbox"/>
7.10	Does system generate Patient admission statistics by date, ward and consultant?	<input type="checkbox"/>	<input checked="" type="checkbox"/>	<input type="checkbox"/>	<input type="checkbox"/>	<input type="checkbox"/>	<input checked="" type="checkbox"/>	<input checked="" type="checkbox"/>	<input type="checkbox"/>
7.11	Does system generate Patient discharge statistics by date, ward and consultant?	<input type="checkbox"/>	<input checked="" type="checkbox"/>	<input type="checkbox"/>	<input type="checkbox"/>	<input type="checkbox"/>	<input checked="" type="checkbox"/>	<input checked="" type="checkbox"/>	<input type="checkbox"/>
7.12	Does system generate Bed occupancy statistics by date and ward, by doctor?	<input type="checkbox"/>	<input checked="" type="checkbox"/>	<input type="checkbox"/>	<input type="checkbox"/>	<input type="checkbox"/>	<input checked="" type="checkbox"/>	<input checked="" type="checkbox"/>	<input type="checkbox"/>
7.13	Does system generate Outpatient visit statistics by date and clinic?	<input checked="" type="checkbox"/>	<input checked="" type="checkbox"/>	<input type="checkbox"/>	<input type="checkbox"/>	<input type="checkbox"/>	<input checked="" type="checkbox"/>	<input checked="" type="checkbox"/>	<input checked="" type="checkbox"/>

8.0 Financial Management

S/N	User/Functional Requirements	4PAY	eHMS	BUMI Expert	DAISA	LabNet	AfyaPr o	Care2 X+We bERP	eIntell iHealt h
8.0	GENERAL								
8.1	All transaction vouchers generated in the system are collated and they are posted on daily basis or online onto the system?	<input type="checkbox"/>	<input type="checkbox"/>	<input type="checkbox"/>	<input type="checkbox"/>	<input type="checkbox"/>	<input type="checkbox"/>	<input checked="" type="checkbox"/>	<input type="checkbox"/>
8.2	Does system generate Cash/Credit/Bank Transaction?	<input type="checkbox"/>	<input type="checkbox"/>	<input type="checkbox"/>	<input type="checkbox"/>	<input type="checkbox"/>	<input type="checkbox"/>	<input type="checkbox"/>	<input type="checkbox"/>
8.3	Does system generate Daily Cash Book?	<input type="checkbox"/>	<input type="checkbox"/>	<input type="checkbox"/>	<input type="checkbox"/>	<input type="checkbox"/>	<input type="checkbox"/>	<input type="checkbox"/>	<input type="checkbox"/>
8.4	Does system generate Daily Bank Book?	<input type="checkbox"/>	<input type="checkbox"/>	<input type="checkbox"/>	<input type="checkbox"/>	<input type="checkbox"/>	<input type="checkbox"/>	<input type="checkbox"/>	<input type="checkbox"/>
8.5	Does system generate Account Receivable Statement with Ageing Analysis?	<input type="checkbox"/>	<input type="checkbox"/>	<input type="checkbox"/>	<input type="checkbox"/>	<input type="checkbox"/>	<input type="checkbox"/>	<input type="checkbox"/>	<input type="checkbox"/>
8.6	Does system generate Income & Expense profile department wise / Budget wise?	<input type="checkbox"/>	<input type="checkbox"/>	<input type="checkbox"/>	<input type="checkbox"/>	<input type="checkbox"/>	<input type="checkbox"/>	<input type="checkbox"/>	<input type="checkbox"/>
8.7	Does system generate Supplier Ledger?	<input type="checkbox"/>	<input type="checkbox"/>	<input type="checkbox"/>	<input type="checkbox"/>	<input type="checkbox"/>	<input type="checkbox"/>	<input type="checkbox"/>	<input type="checkbox"/>
8.8	Does system generate General Ledger?	<input type="checkbox"/>	<input type="checkbox"/>	<input type="checkbox"/>	<input type="checkbox"/>	<input type="checkbox"/>	<input type="checkbox"/>	<input type="checkbox"/>	<input type="checkbox"/>
8.9	Does system generate Trial Balance?	<input type="checkbox"/>	<input type="checkbox"/>	<input type="checkbox"/>	<input type="checkbox"/>	<input type="checkbox"/>	<input type="checkbox"/>	<input type="checkbox"/>	<input type="checkbox"/>

S/N	User/Functional Requirements	4PAY	eHMS	BUMI Expert	DAISA	LabNet	AfyaPr o	Care2 X+We bERP	eIntell iHealt h
8.10	Does system generate P & L?	<input type="checkbox"/>	<input type="checkbox"/>	<input type="checkbox"/>	<input type="checkbox"/>	<input type="checkbox"/>	<input type="checkbox"/>	<input type="checkbox"/>	<input type="checkbox"/>
8.11	Does system generate Balance Sheet?	<input type="checkbox"/>	<input type="checkbox"/>	<input type="checkbox"/>	<input type="checkbox"/>	<input type="checkbox"/>	<input type="checkbox"/>	<input type="checkbox"/>	<input type="checkbox"/>
8.12	Does system generate Expenditure Analysis?	<input type="checkbox"/>	<input type="checkbox"/>	<input type="checkbox"/>	<input type="checkbox"/>	<input type="checkbox"/>	<input type="checkbox"/>	<input type="checkbox"/>	<input type="checkbox"/>
8.13	Does system generate Exception Analysis?	<input type="checkbox"/>	<input type="checkbox"/>	<input type="checkbox"/>	<input type="checkbox"/>	<input type="checkbox"/>	<input type="checkbox"/>	<input type="checkbox"/>	<input type="checkbox"/>

